

USER MANUAL

THETIS-I

2611011021010 /
2611011021110

VERSION 1.5

JUNE 29, 2023

WÜRTH ELEKTRONIK MORE THAN YOU EXPECT

MUST READ

Check for firmware updates

Before using the product make sure you use the most recent firmware version, data sheet and user manual. This is especially important for Wireless Connectivity products that were not purchased directly from Würth Elektronik eiSos. A firmware update on these respective products may be required.

We strongly recommend to include in the customer system design, the possibility for a firmware update of the product.

Revision history

Manual version	FW version	HW version	Notes	Date
1.0	1.0	1.2	<ul style="list-style-type: none"> Initial release 	February 2021
1.1	1.0	1.2	<ul style="list-style-type: none"> Updated ordering information, chapter 1.3. Updated links and references in chapter 4.4. 	May 2021
1.2	1.0	1.2	<ul style="list-style-type: none"> Moved part of chapter 5 to new chapter "Host Connection" (6). 	August 2021
1.3	1.0	1.2	<ul style="list-style-type: none"> Included 2611011021110, Thetis-I w/o license fee, for customers who already have a Wirepas license. Added section "Overview of helpful application notes". 	August 2022
1.4	1.0	1.2	<ul style="list-style-type: none"> Added new radio certification for UKCA in chapter 17.6 and India in chapter 17.10 Website links corrected Updated documents style 	May 2023
1.5	1.0	1.2	<ul style="list-style-type: none"> Added certificates in addition to the required compliance statements in chapter Regulatory compliance information. 	June 2023

Abbreviations

Abbreviation	Name	Description
ARM	Advanced RISC Machine	
BYOF	Build Your Own Firmware	Service to bring firmware developed by customer on the Thetis-I hardware during production and create an own custom article number
COM	Communication Port	
CPU	Central Processing Unit	
CRC	Cyclic Redundancy Check	
CSAP	Configuration Service Access Point	UART control command for module configuration
DC	Direct Current	
DSAP	Data Service Access Point	UART control command for radio data transmission and reception
ESD	Electrostatic Discharge	
FCC	Federal Communications Commission	
FSE	Field Sales Engineer	Support and sales contact person responsible for limited sales area
0xhh [HEX]	Hexadecimal	All numbers beginning with 0x are stated as hexadecimal numbers. All other numbers are decimal.
FTDI	Future Technology Devices International Ltd	USB-to-Serial converter chip
FW	Firmware	
GND	Ground	Ground signal level that corresponds to 0 V
GPIO	General Purpose Input/Output	
HIGH		High signal level that corresponds to VCC
HW	Hardware	
I ² C	Inter-Integrated Circuit	
IC	Integrated Circuit	
IO	Input & Output	
IOT	Internet Of Things	
LED	Light Emitting Diode	
LFCLK	Low Frequency Clock	
LFXO	Low Frequency Crystal Oscillator	

LOW		Low signal level that corresponds to 0 V
LPM	Low Power Mode	Operation mode for reduced power consumption
LSB	Least Significant Bit	
MCU	Micro Controller Unit	
MSAP	Management Service Access Point	UART control command for module management
MSB	Most Significant Bit	
OTA	Over-the-Air	
PC	Personal Computer	
PCB	Printed Circuit Board	
PER	Packet Error Rate	
RAM	Random Access Memory	
RED	Radio Equipment Directive	
RF	Radio Frequency	Describes everything relating to the wireless transmission
SLIP	Serial Line Internet Protocol	
SPI	Serial Peripheral Interface	
SWD	Serial Wire Debug	
TTL	Transistor-Transistor Logic	
UART	Universal Asynchronous Receiver Transmitter	The UART allows communicating with the module of a specific interface
USB	Universal Serial Bus	
VDD	Supply voltage	

Contents

Overview of helpful application notes	7
1. Introduction	8
1.1. Wirepas™ technology	9
1.2. Block diagram	9
1.3. Ordering information	10
2. Electrical specifications	11
2.1. Recommended operating conditions	11
2.2. Absolute maximum ratings	12
2.3. Power consumption	13
2.4. Radio characteristics	15
2.5. Pin characteristics for digital IO	16
3. Pinout	17
4. Quick start	19
4.1. Minimal pin connections	19
4.2. Antenna connection	21
4.2.1. On-board PCB antenna	21
4.2.2. External antenna	21
4.3. Power up	22
4.4. Quick start example	22
4.4.1. Prerequisites	22
4.4.2. Setup description	22
4.4.3. Start-up	22
4.4.4. Configure the radio modules	23
4.4.5. Transmit and receive data	25
5. Functional description	27
5.1. State indication using the LED pins	27
6. Host connection	28
6.1. Serial Interface: UART	28
6.1.1. Settings	28
6.1.2. Messages and <i>DATA_IND</i> pin	28
6.1.3. Frame format	30
6.1.4. SLIP encoding	32
7. Custom firmware	33
7.1. Custom configuration of standard firmware	33
7.2. Customer specific firmware	33
7.3. Customer firmware	33
7.4. Contact for firmware requests	34
8. Firmware updates	35
8.1. Firmware update using the Thetis-I OTA bootloader	35

9. Firmware history	36
10. Design in guide	37
10.1. Advice for schematic and layout	37
10.2. Dimensioning of the micro strip antenna line	39
10.3. Antenna solutions	40
10.3.1. Wire antenna	41
10.3.2. Chip antenna	41
10.3.3. PCB antenna	41
10.3.4. Antennas provided by Würth Elektronik eiSos	42
10.3.4.1. 2600130021 - Himalia - 2.4 GHz dipole antenna	42
11. Reference design	43
11.1. Low Frequency Crystal	43
11.2. Reference Design: Thetis-I Mini EV Board	45
11.3. Trace design	47
12. Manufacturing information	51
12.1. Moisture sensitivity level	51
12.2. Soldering	51
12.2.1. Reflow soldering	51
12.2.2. Cleaning	53
12.2.3. Potting and coating	53
12.2.4. Other notations	53
12.3. ESD handling	54
12.4. Safety recommendations	54
13. Physical specifications	56
13.1. Dimensions	56
13.2. Weight	56
13.3. Module drawing	57
13.4. Footprint WE-FP-4+	58
13.5. Antenna free area	58
14. Marking	59
14.1. Lot number	59
14.2. General labeling information	60
15. Information for explosion protection	61
16. References	62
17. Regulatory compliance information	63
17.1. Important notice EU	63
17.2. Important notice FCC	63
17.3. Conformity assessment of the final product	63
17.4. Exemption clause	63
17.5. EU Declaration of conformity	64
17.6. UK Declaration of conformity	66

17.7.	FCC Compliance Statement (US)	68
17.7.1.	FCC certificate	68
17.8.	IC Compliance Statement (Canada)	69
17.8.1.	IC certificate	69
17.9.	FCC and IC requirements to OEM integrators	70
17.9.1.	Pre-certified antennas	71
17.10.	ETA-WPC (India)	72
17.10.1	ETA-WPC certificate	72
18.	Important notes	74
18.1.	General customer responsibility	74
18.2.	Customer responsibility related to specific, in particular safety-relevant applications	74
18.3.	Best care and attention	74
18.4.	Customer support for product specifications	74
18.5.	Product improvements	75
18.6.	Product life cycle	75
18.7.	Property rights	75
18.8.	General terms and conditions	75
19.	Legal notice	76
19.1.	Exclusion of liability	76
19.2.	Suitability in customer applications	76
19.3.	Trademarks	76
19.4.	Usage restriction	76
20.	License terms	78
20.1.	Limited license	78
20.2.	Usage and obligations	78
20.3.	Ownership	79
20.4.	Firmware update(s)	79
20.5.	Disclaimer of warranty	79
20.6.	Limitation of liability	80
20.7.	Applicable law and jurisdiction	80
20.8.	Severability clause	80
20.9.	Miscellaneous	80
A.	Additional CRC16 Information	83
A.1.	Example CRC Implementation	83
A.2.	CRC Test Vectors	84

Overview of helpful application notes

Application note ANR008 - Wireless Connectivity Software Development Kit

<http://www.we-online.com/ANR008>

To ease the integration of the Würth Elektronik eiSos radio modules into an application, Würth Elektronik eiSos offers the corresponding Software Development Kit (SDK) for most commonly used host processors. This SDK contains drivers and examples in C-code to communicate with the corresponding radio module. This application note shows which SDKs are available and describes how to download and use them.

Application note ANR010 - Range estimation

<http://www.we-online.com/ANR010>

This application note presents the two most used mathematical range estimation models, Friis and two ray ground reflection, and its implementation in the range estimation tool of the RED-EXPERT.

1. Introduction

This manual is valid for the following Thetis-I variants:

- 2611011021010
- 2611011021110

The Thetis-I is a radio module implementing the Wirepas Mesh wireless connectivity stack. It is meant to be integrated in Wirepas-based routing mesh networks for wireless communication between devices or nodes. Main applications are logistics, asset tracking, smart lighting, IoT and smart metering. Operating in the globally available 2.4 GHz license free radio frequency band, the Thetis-I offers a robust and secure data transmission.

The optimized routing technique offered by the Wirepas stack ensures high scalability, reliability and cost-efficiency. Interfacing with the host system via serial UART, the module allows easy integration in a mesh network. Wirepas command interface allows configuration and control of the radio module.

Small dimensions comparable to a nano-SIM card (8 x 12 mm) including an on-board PCB antenna make the Thetis-I ideal for small form factor design.

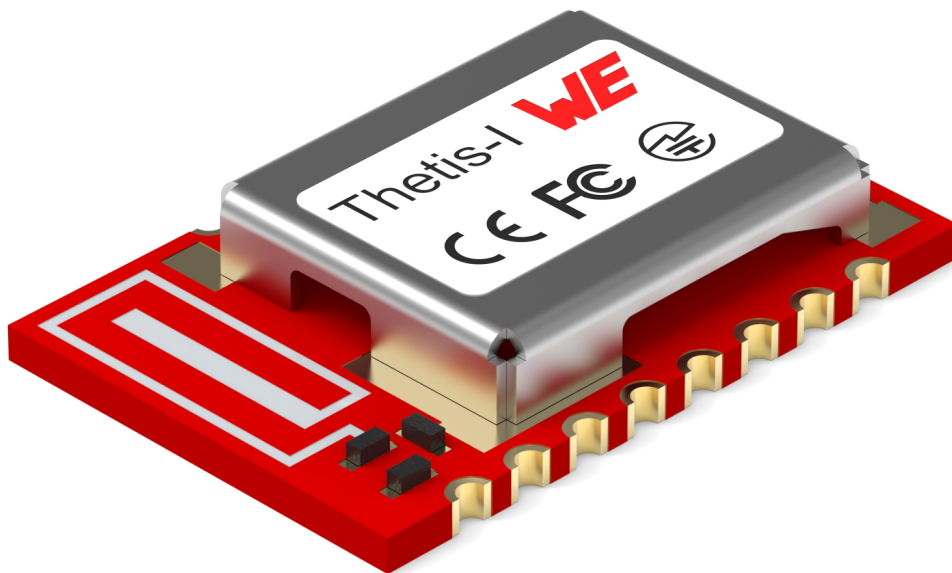

Figure 1: Thetis-I

1.1. Wirepas™ technology

As an official partner of Wirepas™, Würth Elektronik eiSos is authorized to make commercial use of Wirepas firmware for the purposes of normal business.

1.2. Block diagram

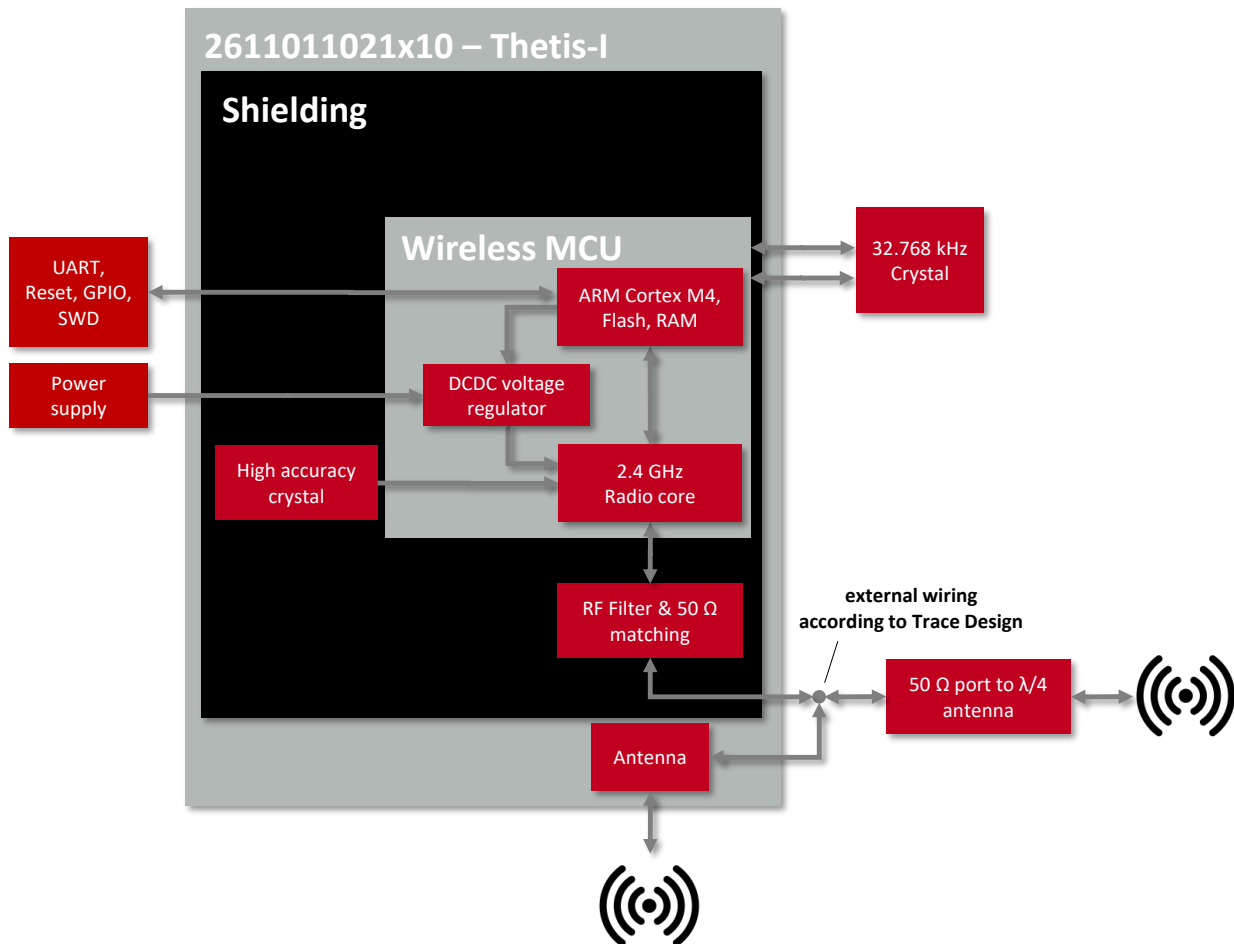

Figure 2: Block diagram

1.3. Ordering information

WE order code	Description
2611011021010	Thetis-I Dual MCU ¹ Wirepas radio module, Tape & Reel
2611011021110	Thetis-I Dual MCU ¹ Wirepas radio module w/o license fee ² , Tape & Reel
2611019021011	Thetis-I Evaluation Kit
2611109021011	Thetis-I Mini Evaluation Board
2611097021021	Thetis-I Sensor Node
2611086021011	Thetis-I USB Radio Stick

Table 1: Ordering information

¹Dual MCU means the use of two microcontrollers. The first controller is integrated in the Thetis-I module and is responsible for the RF communication. The second controller is not part of the Thetis-I. It is responsible for the application and controls the Thetis-I radio module via UART commands.

²A Thetis-I module without license is only available for customers that already have a license with Wirepas directly.

2. Electrical specifications

Unless otherwise stated, the values specified are measured with $T = 25\text{ °C}$, $V_{DD} = 3\text{ V}$, $f = 2.44\text{ GHz}$, internal DC-DC converter in use.

2.1. Recommended operating conditions

Description	Min.	Typ.	Max.	Unit
Ambient temperature	-40	25	85	°C
Supply voltage (VDD)	1.8	3	3.6	V
Supply rise time (0V to $\geq 1.8\text{ V}$)			60	ms

Table 2: Recommended operating conditions



The on-chip power-on reset circuitry may not function properly for rise times longer than the specified maximum.



A step in supply voltage of 300 mV or more, with rise time of 300 ms or less, within the valid supply range, may result in a system reset.



An unstable supply voltage may significantly decrease the radio performance and stability.



Flash erase/write is prohibited if the supply voltage is below 2.7 V and hence configuration of the module cannot be changed. This is done in order to prevent flash corruption when performing a write operation.

2.2. Absolute maximum ratings

Description	Min.	Typ.	Max.	Unit
Supply voltage (VDD)	-0.3		+3.9	V
Voltage on any digital pin, $VDD \leq 3.6$ V	-0.3		VDD+0.3	V
Voltage on any digital pin, $VDD \geq 3.6$ V	-0.3		3.9	V
Input RF level			10	dBm
Flash endurance	10000			Write/erase cycles

Table 3: Absolute maximum ratings

2.3. Power consumption

The specified values combine the consumption of the Cortex M4 (4.1 mA @ 64 MHz) application processor as well as the radio IC. The measurement was done using the external antenna type "Himalia".

Continuous test mode	Min.	Typ.	Max.	Unit
TX current consumption at +8 dBm		16.4 ¹		mA
TX current consumption at 0 dBm		6.4 ¹		mA
RX current consumption		6.25 ¹		mA
TX current consumption at +8 dBm		18.9 ²		mA
TX current consumption at 0 dBm		8 ²		mA
RX current consumption		7.7 ²		mA
Sleep (NRLS) ³		3.2		µA

Table 4: Power consumption for 100% transmission/reception

¹Transmitter only with DC/DC converter from nRF52 data sheet, CPU current not included.

²Full module power consumption.

³NRLS: Non-Router Long Sleep. The stated value is the average current.

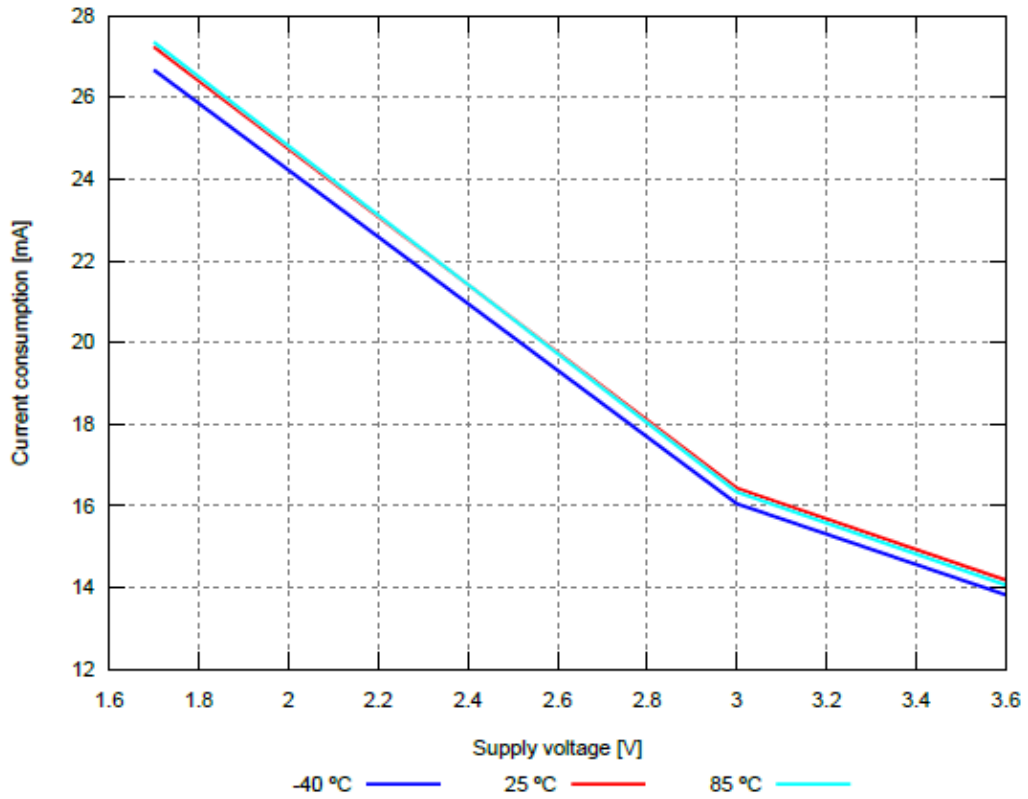

Figure 3: Radio transmitting @ 8 dBm output power, 1 Mbps radio profile, Clock = HFXO (typical)

2.4. Radio characteristics

Description	Typ.	Unit
Output power conducted	+6	dBm
Output power integrated antenna	+4	dBm
Input sensitivity conducted (BER=1E-3, 1 Mbps)	-92	dBm
Input sensitivity integrated antenna (BER=1E-3, 1 Mbps)	-90	dBm

Table 5: Transmit and Receive Power

The values already include losses of transitions from module to motherboard to SMA or modules PCB antenna. They are realistic values for the end application. Sensitivity in the table above is stated for the common used Bit error Rate of 0.1 %. In the table below the sensitivity is stated for a packet error rate of 1 % with a payload length of 38 bytes at 1000 kbit/s data rate. The PER 1 % is a harder criteria resulting in 2 dBm less sensitivity.

Data rate [kbit/s]	Sensitivity (typ.)	Unit
1000 (PER 1%)	-90	dBm

Table 6: Sensitivity at 1000 kbit/s data rate

2.5. Pin characteristics for digital IO

When configured as digital pin output "standard drive" is used in the Thetis-I firmware.

Description	Min.	Typ.	Max.	Unit
Input HIGH voltage	0.7 ×VDD		VDD	V
Input LOW voltage	0		0.3 ×VDD	V
Current at 0.4 V, output set LOW, standard drive, VDD ≥1.8 V	1	2	4	mA
Current at VDD - 0.4 V, output set HIGH, standard drive, VCC ≥1.8 V	1	2	4	mA
Internal pull-up resistance	11	13	16	kΩ
Internal pull-down resistance	11	13	16	kΩ
Digital Output, HIGH	VDD - 0.4		VDD	V
Digital Output, LOW	0		0.4	V

Table 7: Pin characteristics for digital IO

3. Pinout



Reserved pins in terms of Thetis-I are pins not used by the standard firmware the product comes with.

Please refer to the μ C Manual (here: nRF52840 Product Specification) and the column " μ C Pin" of the following table to identify which pins are available to a custom firmware or in case of a BYOF (build your own firmware) approach and which functions can be mapped to those pins.

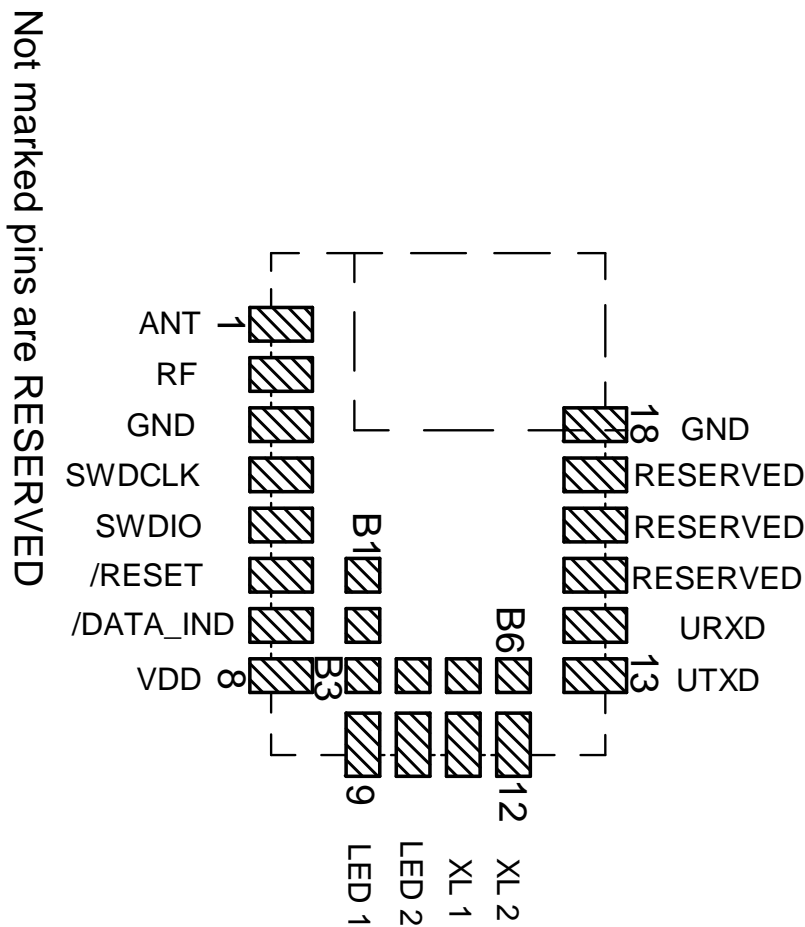

Figure 4: Pinout (top view)

No	μ C Pin	Designation	I/O	Description
1		<i>ANT</i>	RF	RF connection to PCB antenna (see section 4.2)
2		<i>RF</i>	RF	50 Ω RF connection to the transceiver (see section 4.2)

3		<i>GND</i>	Supply	Ground
4		<i>SWDCLK</i>	SWD	Serial wire clock (SWD Interface). Uses internal pull down resistor. Do not connect if not needed.
5		<i>SWDIO</i>	SWD	Serial wire input/output (SWD Interface). Uses internal pull up resistor. Do not connect if not needed.
6	P0.18	<i>/RESET</i>	Input	Reset pin. A low signal resets the module. Uses internal pull up resistor ¹ .
7	P0.02	<i>/DATA_IND</i>	Output	Data indication pin. A low signal indicates that the radio module has UART data to transmit to the host. Do not connect, if not needed. See also chapter 6.1.2.
8		<i>VDD</i>	Supply	Supply voltage
9	P0.19	<i>LED 1</i>	Output	A high signal indicates that no route to a sink is available. Do not connect, if not needed. See also chapter 5.1.
10	P0.22	<i>LED 2</i>	Output	Static low. Do not connect, if not needed. See also chapter 5.1.
11	P0.00/XL1	<i>XL 1</i>	LFXO	Pin to connect external low frequency crystal. ²
12	P0.01/XL2	<i>XL 2</i>	LFXO	Pin to connect external low frequency crystal. ²
13	P1.08	<i>UTXD</i>	Output	UART Transmission to host.
14	P1.09	<i>URXD</i>	Input	UART Reception from host.
15	P0.11	<i>RESERVED</i>	-	Do not connect, reserved for future use.
16	P0.12	<i>RESERVED</i>	-	Do not connect, reserved for future use.
17	P0.03	<i>RESERVED</i>	-	Do not connect, reserved for future use.
18		<i>GND</i>	Supply	Ground
B1	P0.09	<i>RESERVED</i>	-	Do not connect, reserved for future use.
B2	P0.10	<i>RESERVED</i>	-	Do not connect, reserved for future use.
B3	P0.23	<i>RESERVED</i>	-	Do not connect, reserved for future use.
B4	P1.00	<i>RESERVED</i>	-	Do not connect, reserved for future use.
B5	P0.21	<i>RESERVED</i>	-	Do not connect, reserved for future use.
B6	P0.07	<i>RESERVED</i>	-	Do not connect, reserved for future use.

Table 8: Pin description

¹Internal pull ups or pull downs are configured at startup by the firmware installed in the SoC. The pull up on the */RESET* pin cannot be disabled by firmware.

²See chapter Reference Design for crystal specification.

4. Quick start

The Thetis-I comes pre-flashed, tested and ready to use out-of-the box. It is compliant with the several regulatory requirements, which makes it suitable for use in most parts of the world (see chapter 17).

This chapter describes steps to quickly build a prototype system and test the capabilities of the radio module.

4.1. Minimal pin connections

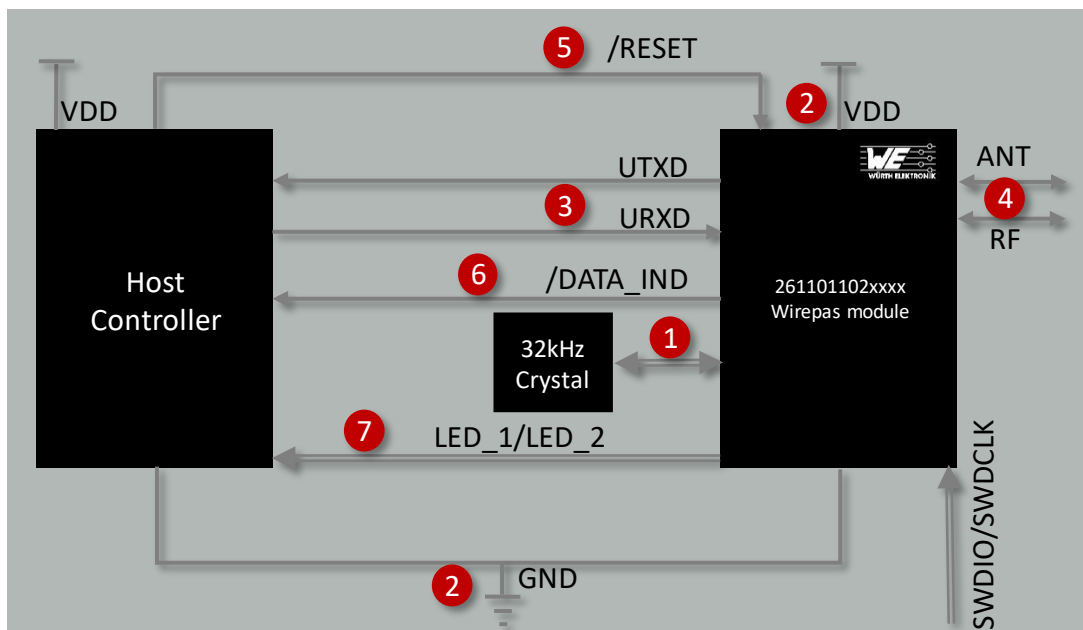

Figure 5: Minimal pin connections

The above image shows the bare minimum steps to be performed to integrate the Thetis-I into a custom end device.

1. **External 32.768 kHz crystal¹**
Connect the 32.768 kHz crystal to the Low Frequency Oscillator pins *XL 1* and *XL 2*.
2. **Supply voltage and ground**
Connect the *VDD* and *GND* pins to supply the radio module with power.
3. **UART serial interface to the host**
Connect the UART pins *UTXD* and *URXD* to the *UART RX* and *UART TX* pins of the host controller.

¹See chapter 11 for crystal specifications.

4. Antenna connection

Configure the antenna as per the requirement of the application (see section 4.2).

5. Reset

Connect the */RESET* pin to the host to allow a hard reset of the module.

6. (Optional) Data indication

Connect the */DATA_IND* pin to an interrupt pin of the host controller to check when data is available on the module to transmit to the host controller. This pin can be used to wake-up the host controller from sleep.

7. (Optional) Status indication

Connect the *LED 1* and *LED 2* pins to digital input pins of the host controller to allow easy status indication.

If the module has to be connected to a PC, a converter (TTL to RS-232 or TTL to USB) has to be used. See chapter 3 for details of the module pins and chapter 11 for the reference design.



The logic level of the module is based on 3V. A 5 V logic level shall not be connected directly to the module.

4.2. Antenna connection

Thetis-I's smart antenna configuration enables the user to choose between two antenna options:

4.2.1. On-board PCB antenna

The Thetis-I has an on-board PCB antenna optimized for operating in the 2.4 GHz frequency band. A simple short between the pins *RF* and *ANT* feeds the RF output of the module to the on-board antenna of the Thetis-I. In this configuration, the module does not require any additional RF circuitry. For US and Canada, please refer to the trace design in chapter 11.3.



The integrated antenna is ideal for compact designs where miniaturization is a priority. This configuration also enables re-use of module certifications for the end-application.

4.2.2. External antenna

For applications that use an external antenna, the Thetis-I provides a 50 Ω RF signal on pin *RF* of the module. In this configuration, pin *ANT* of the module has to be connected to ground and pin *RF* to the external antenna via 50 Ω feed line. Refer to chapter 11 for further information.



The external antenna configuration enables optimization of radio range at the cost of additional space on the PCB. This configuration is ideal in situations where a specialized antenna is necessary. For example, when metal housings are used.

4.3. Power up

After powering the module, the */RESET* pin shall be held LOW for another Δt of 1 ms after the *VDD* is stable to ensure a safe start-up.

After starting the Thetis-I *LED 1* goes high, indicating that no connection to a sink node is available. As soon as a connection to a sink has been found, *LED 1* goes low again.

4.4. Quick start example

This section is intended to help the user setup and test the exchange data between two Wirepas radio modules. Minimal pin and antenna connections have to be done on both of the modules as described in sections 4.1 and 4.2.

4.4.1. Prerequisites

The following hardware is required to go through the quick start example.

1. Two Thetis-I mini evaluation boards [2]. Please refer to our online catalogue: <http://www.we-online.com/EVAL-Wirepas>
2. Windows PC with the Wirepas commander tool [4], available for free download at this page: <http://www.we-online.com/Wirepas-Commander>

4.4.2. Setup description

In this example, the two evaluation boards are connected to the PC with Wirepas commander tool installed (see Figure 6).

4.4.3. Start-up

1. Connect the Thetis-I evaluation boards to the laptop/PC via FTDI cable (please refer to the Thetis-I Evaluation Kit user manual [3]).



The FTDI driver for the converter IC on the evaluation board has to be installed and/or updated. Upon correct driver installation, the evaluation board appears as a virtual COM port.

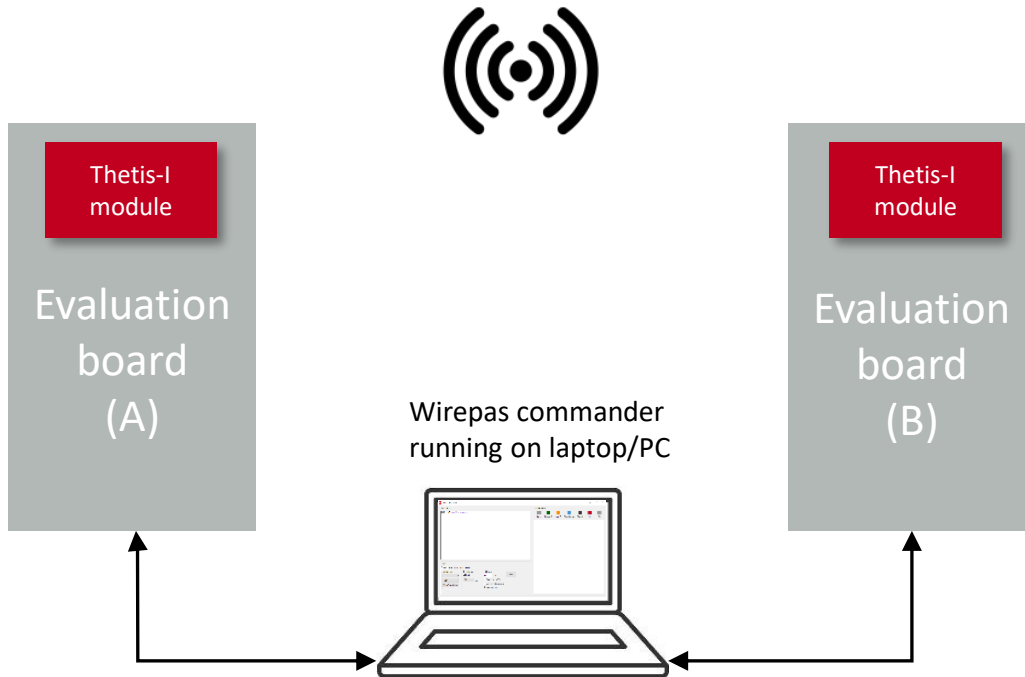

Figure 6: Setup quick start

2. Open two instances of the Wirepas commander.
3. Open an instance of the serial port with COM port settings 115200 Baud, 8n1 for each Thetis-I evaluation board in the Wirepas commander instances.

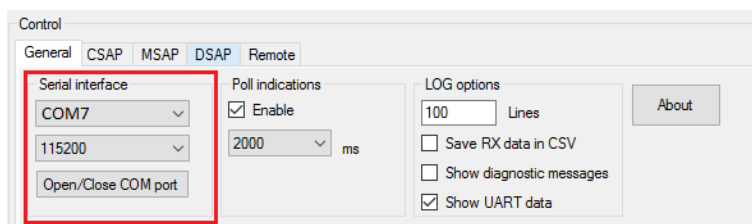

Figure 7: Open the COM port

4.4.4. Configure the radio modules

1. Configure module A as sink node by performing the following steps:
 - a) Go to the Wirepas commander that is connected to module A.

- b) Go to the "Configuration" tab and set a unique node address, set the network address, set the network channel and set the node role to "SINK" (e.g. 1 for node address, network address and network channel, refer to Figure 8).

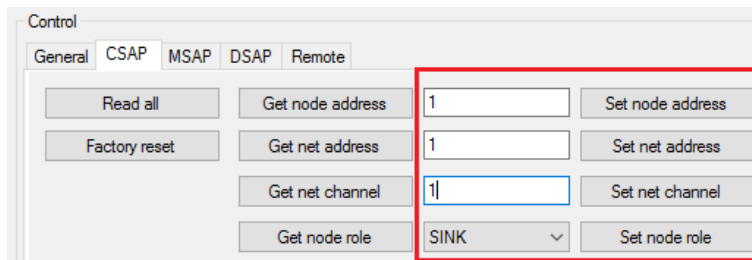

Figure 8: Configure the node

- c) Go to the "Management" tab and start the stack.

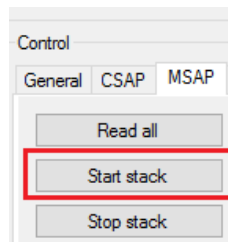

Figure 9: Start the stack

2. Configure module B as router node by performing the following steps:
 - a) Go to the Wirepas commander that is connected to module B.
 - b) Go to the "Configuration" tab and set a unique node address, set the network address, set the network channel and set the node role to "ROUTER_NODE".

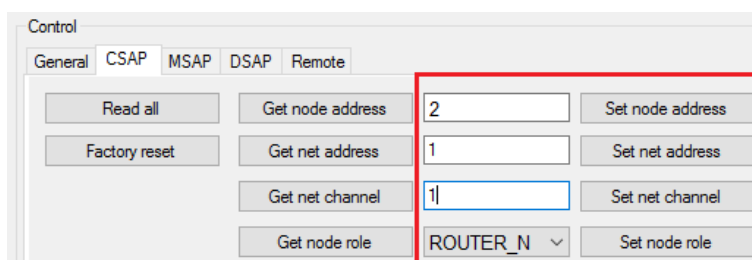

Figure 10: Configure the node

- c) Go to the "Management" tab and start the stack.
3. In the Wirepas commander that is connected to module B, on the "Management" tab repeatedly press and release the "Get route count"-button as long as it returns 0. If 1 is returned, the router node is connected to the sink node.

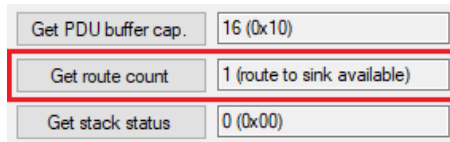

Figure 11: Check whether a connection to the sink exists

4.4.5. Transmit and receive data

1. Go to the "Data" tab of the Wirepas commander that is connected to module B.
2. Enter in the destination address field "sink".
3. Enter in the data field the data you want to transmit.
4. Press the "TX request"-button.

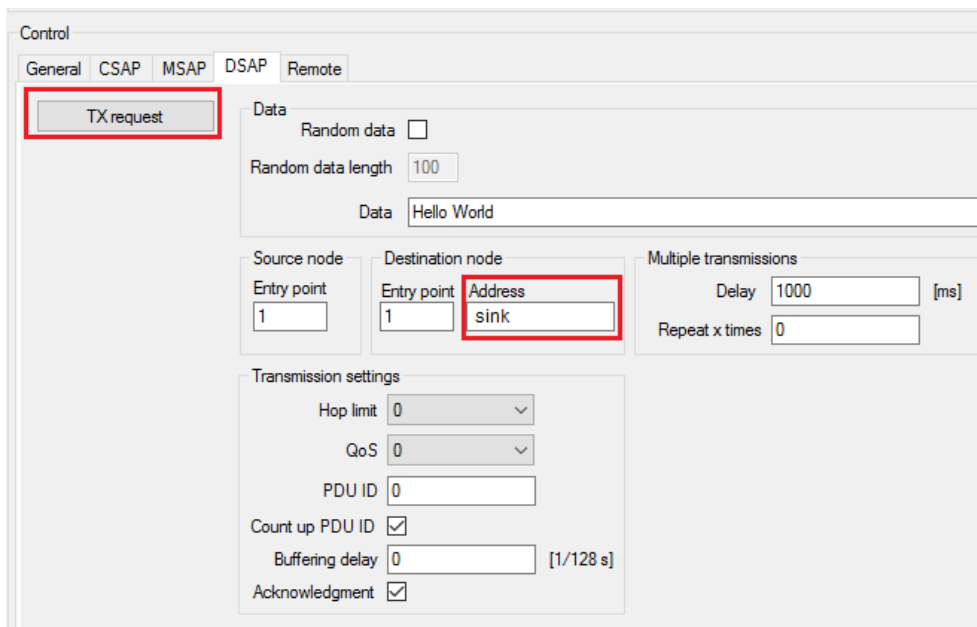

Figure 12: Transmit "Hello world" from module B

5. Go to the Wirepas commander that is connected to module A. A "DSAP_DATA_RX_INDICATION" message appears as soon as the radio data has been received and a "MSAP_INDICATION_POLL_REQUEST" message has been sent from the Wirepas commander to the radio module.

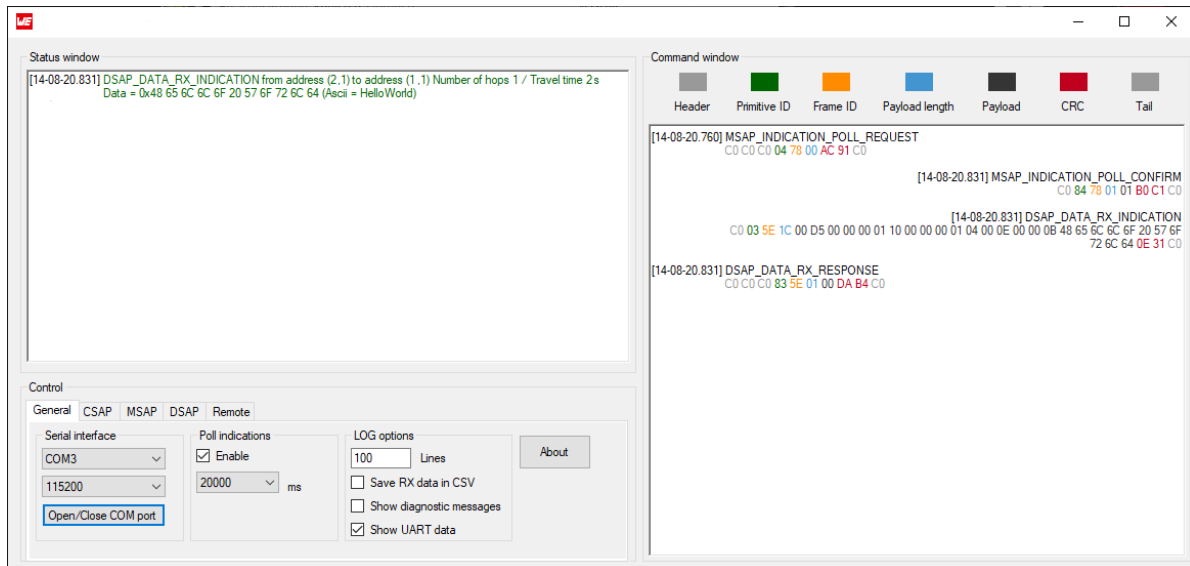

Figure 13: Receive "Hello world" on module A

5. Functional description

The Thetis-I acts as a slave and can be fully controlled by an external host that implements the C-mesh command interface. The configuration as well as the operation of the module can be managed by predefined commands that are sent as telegrams over the UART interface of the module.

Please refer to Chapter 6 for more information about the UART settings and messages.

The function and command set of the Thetis-I bases on the dual MCU firmware developed by Wirepas. See the Wirepas dual MCU manual [1] for the full documentation.

5.1. State indication using the LED pins

The LED pins of the Thetis-I can be used to determine the module state. The pins are active high.

State	LED 1	LED 2
No route to sink node found	On	Off
Route to sink node found	Off	Off

Table 9: LED behaviour of the Thetis-I

6. Host connection

6.1. Serial Interface: UART

The Thetis-I is intended to be used as a radio module in a system, interfaced with a host micro-controller. The use of industry standard UART as the primary interface ensures a very minimal requirement set on the host MCU. As a result of this, the module can be designed in with most host controllers from a 8051 to the more advanced ARM core architecture.

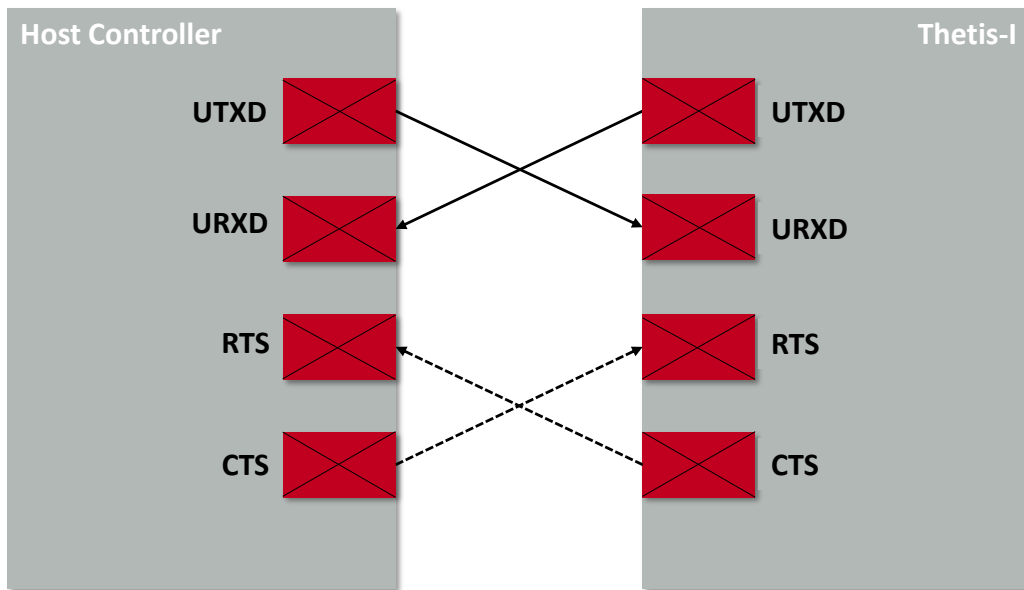

Figure 14: Host Interface

6.1.1. Settings

The UART of the Thetis-I uses 115200 Baud "8n1" (8 data Bits, no parity and 1 stop Bit) without flow control pins. It sleeps as long as no data is sent to or from the radio module, which enables low power operation of the Thetis-I.

6.1.2. Messages and *DATA_IND* pin

The UART messages can be divided into four types:

- Requests: The host requests the module to trigger any action, i.e. to transmit data or to configure the radio module.
- Confirm: On each request, the module answers with a confirmation message to give a feedback on the requested operation status.
- Indications: An indication is a spontaneous message from the radio module to the host controller, i.e. if data has been received via radio.
- Response: A response is a reply from the host controller to the indication message.

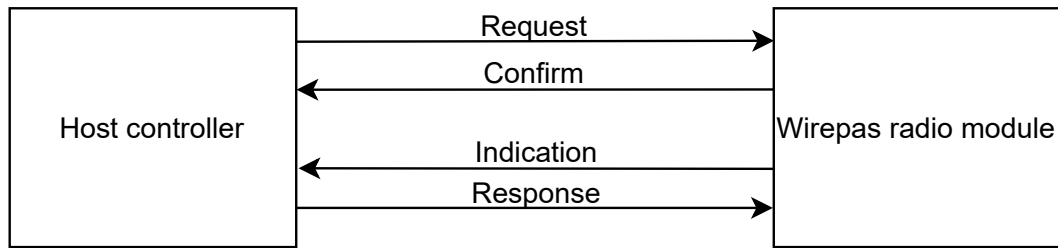

Figure 15: Message types

There are mainly two use cases:

1. The host triggers any action:
In this case, the host sends a request to the Thetis-I, which responds with a confirmation message.
2. The radio module has data to be sent to the host:
In this case, the signal level of the *DATA_IND* pin switched from HIGH to LOW to tell the host that data is available. Next the host sends a *MSAP_INDICATION_POLL_REQUEST* message to request the available data. The radio module responds with a *MSAP_INDICATION_POLL_CONFIRM* message followed by the indication message containing the available data. The host controller must then reply to the indication message with a response message. Then the *DATA_IND* pin switched from LOW to HIGH again. See also Figure 16.

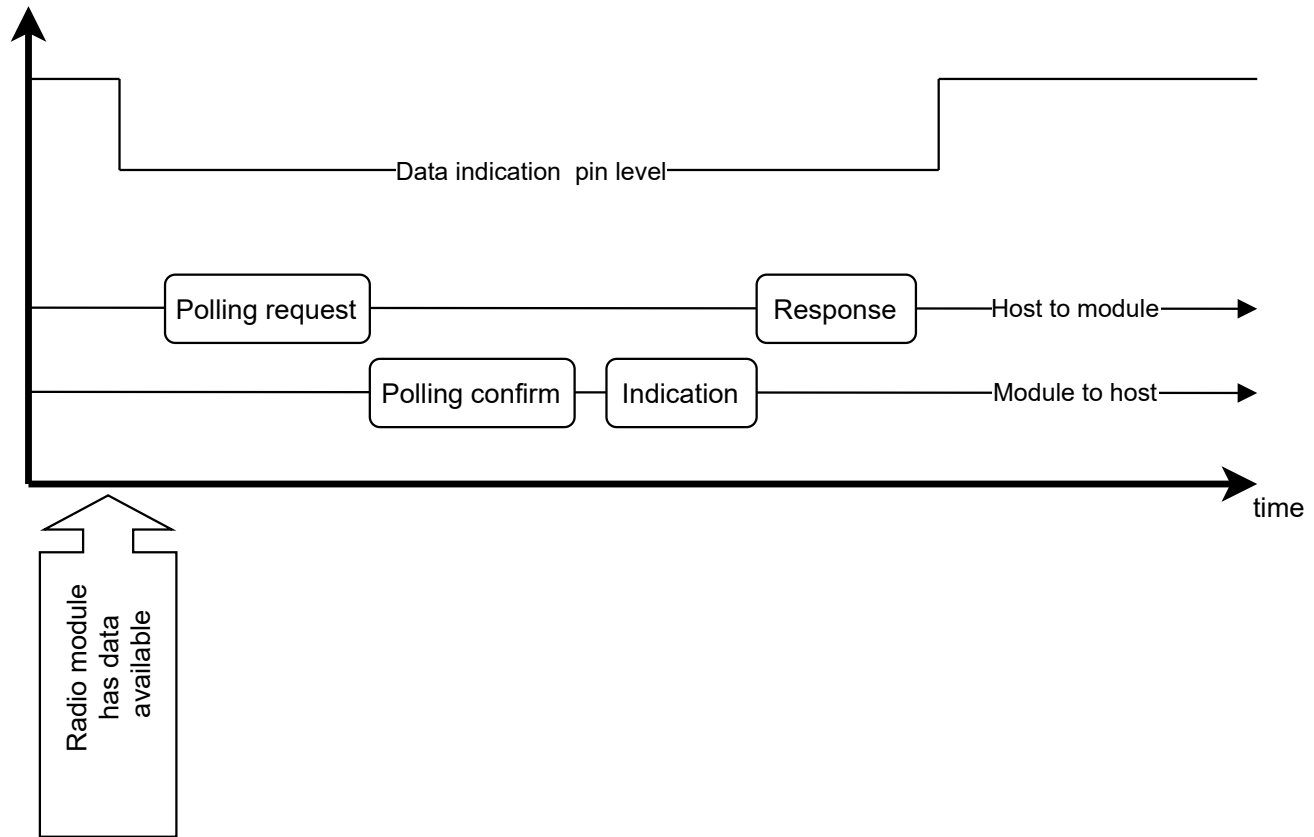

Figure 16: Message flow

6.1.3. Frame format



In this section, two special characters are defined. 0xC0 is called END, where 0xDB is called ESC

The frame format of a UART message is as shown in Figure 17. It starts with one to three END bytes, followed by a SLIP encoded frame followed by a single END byte. Messages from radio module to host use one END byte at the message start, where messages from host to radio module must use three END bytes at the message start. This allows the Thetis-I to power up its UART before the SLIP encoded frame arrives.

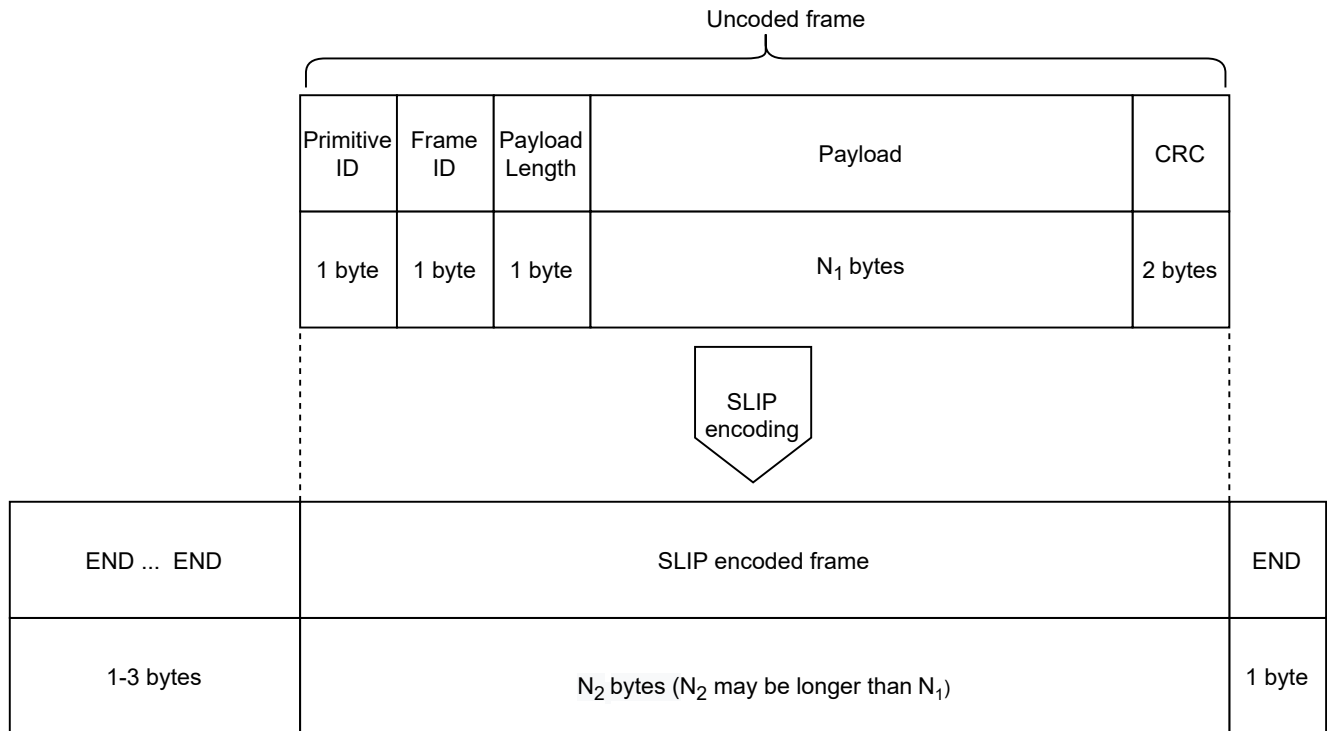

Figure 17: Frame format

Name	Length	Description
Primitive ID	1	The primitive ID defines the type of command. Initiating primitives (request-primitives from the host side and indication-primitives from the radio module side) have always the most significant bit set to 0. Responding primitives (confirm-primitives from the radio module side and response-primitives from the host side) always have the most significant bit set to 1.
Frame ID	1	The host controller decides the frame ID for a request-primitive and the radio module sends corresponding confirm-primitive with the same frame ID. The radio module decides the frame ID for an indication-primitive and the host controller sends corresponding response-primitive with the same frame ID.
Payload length	1	Length of the following payload field in bytes, excluding the CRC bytes.
Payload	N_1	The payload of the frame.
CRC	2	Checksum over the whole frame that has not been SLIP encoded, excluding the CRC octets. When receiving a frame, the SLIP encoding is removed and the CRC is calculated over the decoded frame. When sending a frame, the CRC is calculated first and SLIP encoding is employed after that. See Annex A for details.

Table 10: Uncoded frame

Please refer to the Wirepas dual MCU manual [1] for details of the available commands.

6.1.4. SLIP encoding

To encode an uncoded frame by SLIP the following actions have to be performed:

- Any byte of value 0xC0 (END) within the frame is encoded as 0xDB (ESC), 0xDC.
- Any byte of value 0xDB (ESC) within the frame is encoded as 0xDB (ESC), 0xDD.
- Any other byte is passed through as-is.

Thus, the encoded frame may be longer (N_2) than the uncoded frame (N_1).

7. Custom firmware

7.1. Custom configuration of standard firmware

The configuration of the standard firmware includes adoption of the settings to customer requirements and creating a customized product on base of the standard product.



This variant will result in a customer exclusive module with a unique ordering number. It will also freeze the firmware version to a specific and customer tested version.

Further scheduled firmware updates of the standard firmware will not be applied to this variant automatically. Applying updates or further functions require a customer request and release procedure.

7.2. Customer specific firmware

A customer specific firmware may include "Custom configuration of standard firmware" plus additional options or functions and tasks that are customer specific and not part of the standard firmware.



Further scheduled firmware updates of the standard firmware will not be applied to this variant automatically. Applying updates or further functions require a customer request and release procedure.

This also results in a customer exclusive module with a unique ordering number. An example for this level of customization are functions like host-less operation where the module will perform data generation (e.g. by reading a SPI or I²C sensor) and cyclic transmission of this data to a data collector, while sleeping or being passive most of the time. Also replacing UART with SPI as host communication interface is classified as a custom specific option.

Certification critical changes need to be re-evaluated by an external qualified measurement laboratory. These critical changes may occur when e.g. changing radio parameters, the channel access method, the duty-cycle or in case of various other functions and options possibly used or changed by a customer specific firmware.

7.3. Customer firmware

A customer firmware is a firmware written and tested by the customer himself or a 3rd party as a customer representative specifically for the hardware platform provided by a module. This customer firmware (e.g. in form of an Intel hex file) will be implemented into the module's production process at our production side.

This also results in a customer exclusive module with a unique ordering number. The additional information needed for this type of customer firmware, such as hardware specific details and details towards the development of such firmware are not available for the public

and can only be made available to qualified customers.



The qualification(s) and certification(s) of the standard firmware cannot be applied to this customer firmware solution without a review and verification.

7.4. Contact for firmware requests

Please contact your local field sales engineer (FSE) or WCS@we-online.com for quotes regarding this topic.

8. Firmware updates

All products will experience maintenance, security and/or feature updates from time to time. For the standard products these are maintained via the PCN process.

Customers can request the creation of a customized product including a "firmware freeze" to ensure that they will receive their verified product even if the standard product is updated.

As this product uses a RF stack made by Wirepas, the stack version used inside the Würth Elektronik eiSos standard firmware for Thetis-I may be older than the most recent stack version that is available by Wirepas directly.

Get in contact with our sales team if you have a request for a custom firmware including a newer Wirepas stack version.

8.1. Firmware update using the Thetis-I OTA bootloader

The Thetis-I supports Wirepas over the air firmware update. When planning an OTA update, following items have to be considered:

- an agreement between customer and Würth Elektronik eiSos is required to ensure protection of the intellectual property of Wirepas and Würth Elektronik eiSos
- the customer shall use the Wirepas commander tool to control the network's sink and use it to distribute the firmware update over the entire network



OTA updates lead to increased network traffic and can have impact on the battery lifetime of battery-powered nodes.

9. Firmware history

Version 1.0.0 "Release"

- First production release
- Wirepas stack version 5.0.2.0, C-mesh API version 13

10. Design in guide

10.1. Advice for schematic and layout

For users with less RF experience it is advisable to closely copy the relating evaluation board with respect to schematic and layout, as it is a proven design. The layout should be conducted with particular care, because even small deficiencies could affect the radio performance and its range or even the conformity.

The following general advice should be taken into consideration:

- A clean, stable power supply is strongly recommended. Interference, especially oscillation can severely restrain range and conformity.
- Variations in voltage level should be avoided.
- LDOs, properly designed in, usually deliver a proper regulated voltage.
- Blocking capacitors and a ferrite bead in the power supply line can be included to filter and smoothen the supply voltage when necessary.



No fixed values can be recommended, as these depend on the circumstances of the application (main power source, interferences etc.).



The use of an external reset IC should be considered if one of the following points is relevant:



- The slew rate of the power supply exceeds the electrical specifications.
- The effect of different current consumptions on the voltage level of batteries or voltage regulators should be considered. The module draws higher currents in certain scenarios like start-up or radio transmit which may lead to a voltage drop on the supply. A restart under such circumstances should be prevented by ensuring that the supply voltage does not drop below the minimum specifications.
- Voltage levels below the minimum recommended voltage level may lead to malfunction. The /Reset pin of the module shall be held on LOW logic level whenever the VCC is not stable or below the minimum operating Voltage.
- Special care must be taken in case of battery powered systems.

- Elements for ESD protection should be placed on all pins that are accessible from the outside and should be placed close to the accessible area. For example, the RF-pin is accessible when using an external antenna and should be protected.
- ESD protection for the antenna connection must be chosen such as to have a minimum effect on the RF signal. For example, a protection diode with low capacitance such as the 8231606A or a 68 nH air-core coil connecting the RF-line to ground give good results.
- Placeholders for optional antenna matching or additional filtering are recommended.
- The antenna path should be kept as short as possible.



Again, no fixed values can be recommended, as they depend on the influencing circumstances of the application (antenna, interferences etc.).

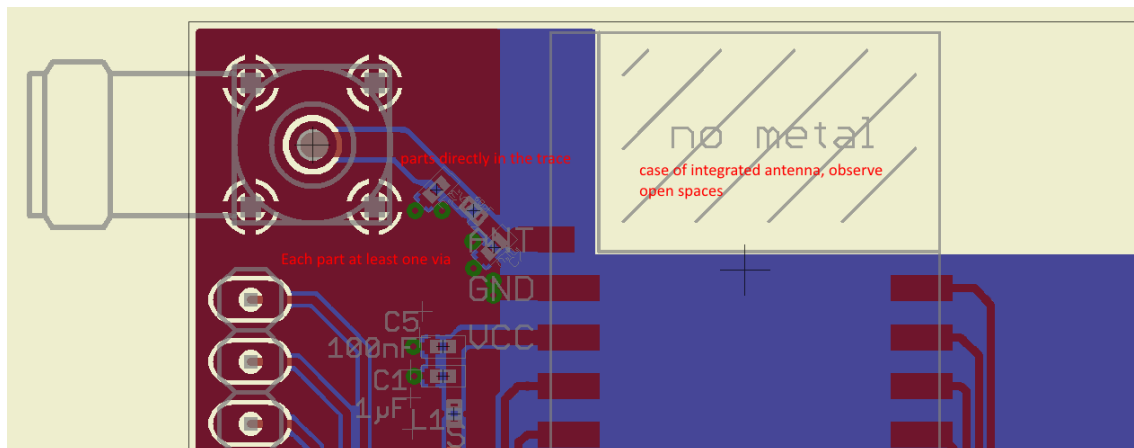

Figure 18: Layout

- To avoid the risk of short circuits and interference there should be no routing underneath the module on the top layer of the baseboard.
- On the second layer, a ground plane is recommended, to provide good grounding and shielding to any following layers and application environment.
- In case of integrated antennas it is required to have areas free from ground. This area should be copied from the evaluation board.
- The area with the integrated antenna must overlap with the carrier board and should not protrude, as it is matched to sitting directly on top of a PCB.
- Modules with integrated antennas should be placed with the antenna at the edge of the main board. It should not be placed in the middle of the main board or far away from the edge. This is to avoid tracks beside the antenna.

- Filter and blocking capacitors should be placed directly in the tracks without stubs, to achieve the best effect.
- Antenna matching elements should be placed close to the antenna / connector, blocking capacitors close to the module.
- Ground connections for the module and the capacitors should be kept as short as possible and with at least one separate through hole connection to the ground layer.
- ESD protection elements should be placed as close as possible to the exposed areas.

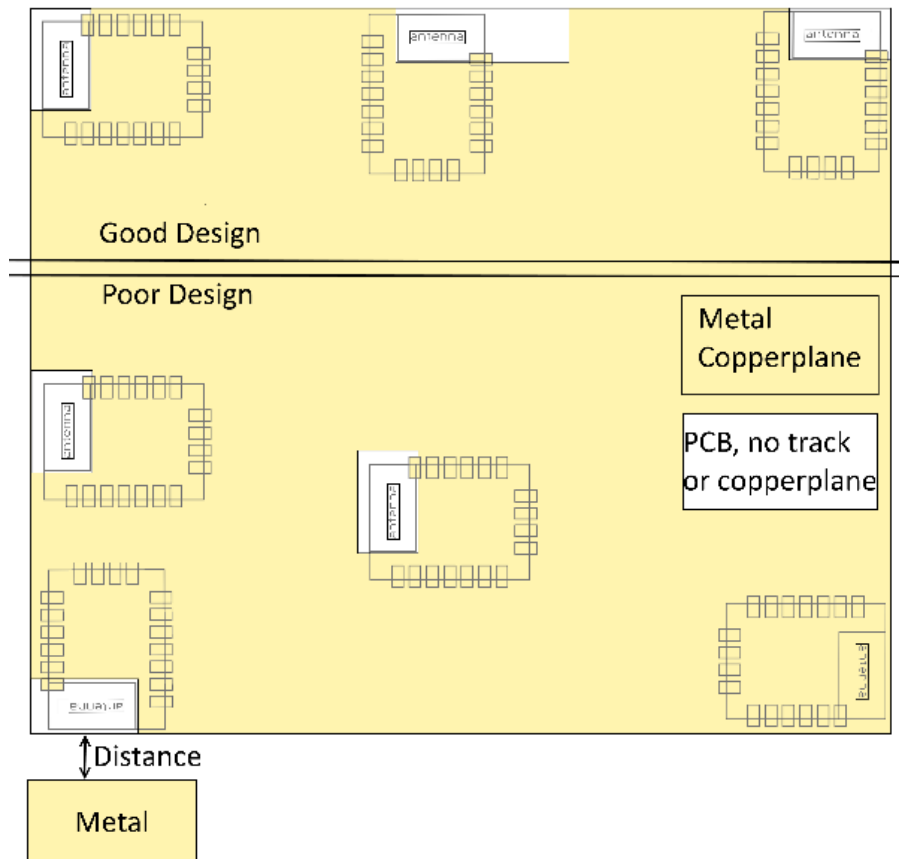

Figure 19: Placement of the module with integrated antenna

10.2. Dimensioning of the micro strip antenna line

The antenna track has to be designed as a 50 Ω feed line. The width W for a micro strip can be calculated using the following equation:

$$W = 1.25 \times \left(\frac{5.98 \times H}{e^{\frac{50 \times \sqrt{\epsilon_r + 1.41}}{87}}} - T_{met} \right) \tag{1}$$

Example:

A FR4 material with $\epsilon_r = 4.3$, a height $H = 1000 \mu\text{m}$ and a copper thickness of $T_{met} = 18 \mu\text{m}$ will

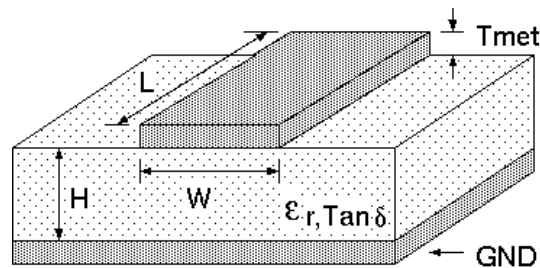

Figure 20: Dimensioning the antenna feed line as micro strip

lead to a trace width of $W \sim 1.9$ mm. To ease the calculation of the micro strip line (or e.g. a coplanar) many calculators can be found in the internet.

- As rule of thumb a distance of about $3 \times W$ should be observed between the micro strip and other traces / ground.
- The micro strip refers to ground, therefore there has to be the ground plane underneath the trace.
- Keep the feeding line as short as possible.

10.3. Antenna solutions

There exist several kinds of antennas, which are optimized for different needs. Chip antennas are optimized for minimal size requirements but at the expense of range, PCB antennas are optimized for minimal costs, and are generally a compromise between size and range. Both usually fit inside a housing.

Range optimization in general is at the expense of space. Antennas that are bigger in size, so that they would probably not fit in a small housing, are usually equipped with a RF connector. A benefit of this connector may be to use it to lead the RF signal through a metal plate (e.g. metal housing, cabinet).

As a rule of thumb a minimum distance of $\lambda / 10$ (which is 3.5 cm @ 868 MHz and 1.2 cm @ 2.44 GHz) from the antenna to any other metal should be kept. Metal placed further away will not directly influence the behavior of the antenna, but will anyway produce shadowing.



Keep the antenna as far as possible from large metal objects to avoid electromagnetic field blocking.



The choice of antenna might have influence on the safety requirements.

In the following chapters, some special types of antenna are described.

10.3.1. Wire antenna

An effective antenna is a $\lambda / 4$ radiator with a suiting ground plane. The simplest realization is a piece of wire. It's length is depending on the used radio frequency, so for example 8.6 cm 868.0 MHz and 3.1 cm for 2.440 GHz as frequency. This radiator needs a ground plane at its feeding point. Ideally, it is placed vertically in the middle of the ground plane. As this is often not possible because of space requirements, a suitable compromise is to bend the wire away from the PCB respective to the ground plane. The $\lambda/4$ radiator has approximately 40 Ω input impedance. Therefore, matching is not required.

10.3.2. Chip antenna

There are many chip antennas from various manufacturers. The benefit of a chip antenna is obviously the minimal space required and reasonable costs. However, this is often at the expense of range. For the chip antennas, reference designs should be followed as closely as possible, because only in this constellation can the stated performance be achieved.

10.3.3. PCB antenna

PCB antenna designs can be very different. The special attention can be on the miniaturization or on the performance. The benefits of the PCB antenna are their small / not existing (if PCB space is available) costs, however the evaluation of a PCB antenna holds more risk of failure than the use of a finished antenna. Most PCB antenna designs are a compromise of range and space between chip antennas and connector antennas.

10.3.4. Antennas provided by Würth Elektronik eiSos

10.3.4.1. 2600130021 - HIMALIA - 2.4 GHz dipole antenna



Figure 21: 2.4 GHz dipole-antenna

Due to the fact, that the antenna has dipole topology there is no need for an additional ground plane. Nevertheless the specification was measured edge mounted and 90 ° bent on a 100 x 100 mm ground plane.

Specification	Value
Frequency range [GHz]	2.4 – 2.5
Impedance [Ω]	50
VSWR	$\leq 2:1$
Polarization	Linear
Radiation	Omni-Directional
Peak Gain [dBi]	2.8
Average Gain [dBi]	-0.6
Efficiency	85 %
Dimensions (L x d) [mm]	83.1 x 10
Weight [g]	7.4
Connector	SMA plug
Operating temp. [$^{\circ}\text{C}$]	-40 – +80

Special care must be taken for FCC certification when using this external antenna to fulfil the requirement of permanently attached antenna or unique coupling for example by using the certified dipole antenna in a closed housing, so that only through professional installation it is possible to remove it.

11. Reference design

Since the Thetis-I is based on the same hardware platform as Proteus-III, it was tested and certified on the corresponding Proteus-III evaluation board. For the compliance with the EU directive 2014/53/EU Annex I, the evaluation board serves as reference design. For the FCC it serves as trace design.

This is no discrepancy due to the fact that the evaluation board itself does not fall within the scope of the EU directive 2014/53/EU Annex I as the module is tested on the evaluation board, which is also the recommended use.



The shown Evaluation Board is the proven design for the conformity topics.

11.1. Low Frequency Crystal

The Thetis-I needs a low frequency watch crystal to stay synchronized in low power modes. For higher LFCLK accuracy (better than $\pm 250\text{ppm}$) a low frequency crystal oscillator of 32.768kHz (LFXO) shall be used. The Würth Elektronik eiSos crystal (order code 830009706), 3.2 × 1.6mm in size, with capacitors C9 (12pF) and C10 (12pF), 0402 package is used in the reference design.

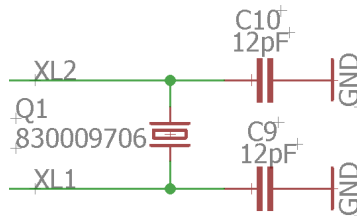

Figure 22: LFXO mounting

Depending on parasitic capacitance of PCB, the capacitance value of C9 and C10 shall be calculated.

nRF52840 pin P0.00/XL1 and P0.01/XL12 are connected to module pad XL1 and XL2 respectively.

The input capacitance of the pad XL1 and XL2 are 4pF. The values of C9 and C10 can be calculated as follows.

The load capacitance of LFXO is given by

$$C_l = \frac{C9_l * C10_l}{C9_l + C10_l} \tag{2}$$

If $C_9 = C_{10} = C$, then

$$C_l = \frac{C}{2} \quad (3)$$

whereas,

$$C_9 = C - C_{XL1} - C_{PCB} \quad (4)$$

$$C_{10} = C - C_{XL2} - C_{PCB} \quad (5)$$

C_l = Load capacitance of LFXO crystal.

C_{XL1} = Input capacitance of Pad XL1 (4pF)

C_{XL2} = Input capacitance of Pad XL2 (4pF)

C_{PCB} = Parasitic capacitance of PCB

Parasitic capacitance of the PCB can vary depending on design and track length. It can vary from 0.5pF to 2pF.

For the crystal *830009706* with load capacitance of 9pF and parasitic capacitance of 2pF (for the Thetis-I Mini EV board), the value of C9 and C10 results in 12pF, which was also tested on the Thetis-I Mini EV board.

11.2. Reference Design: Thetis-I Mini EV Board

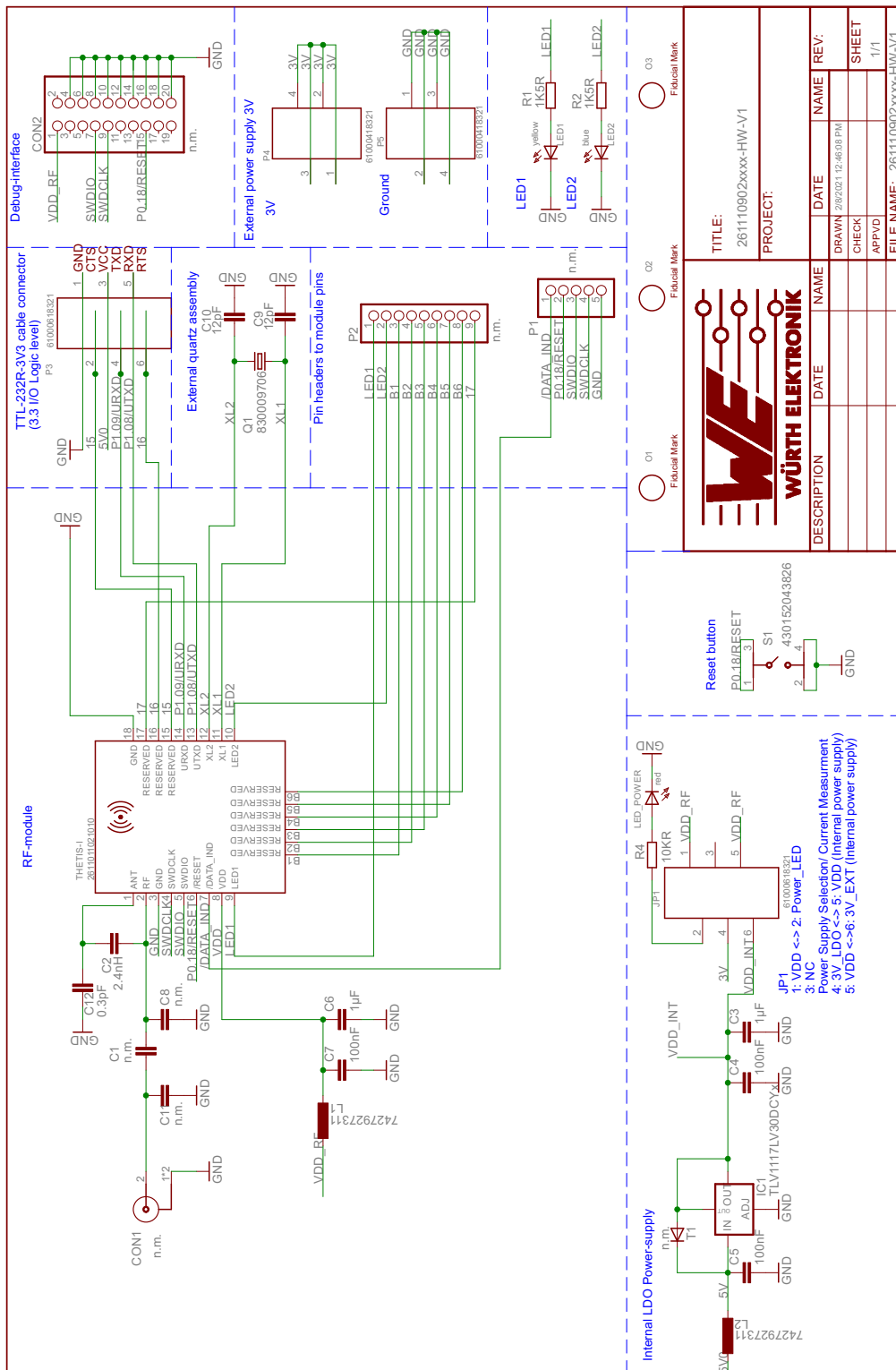

Figure 23: Reference design: Schematic page 1

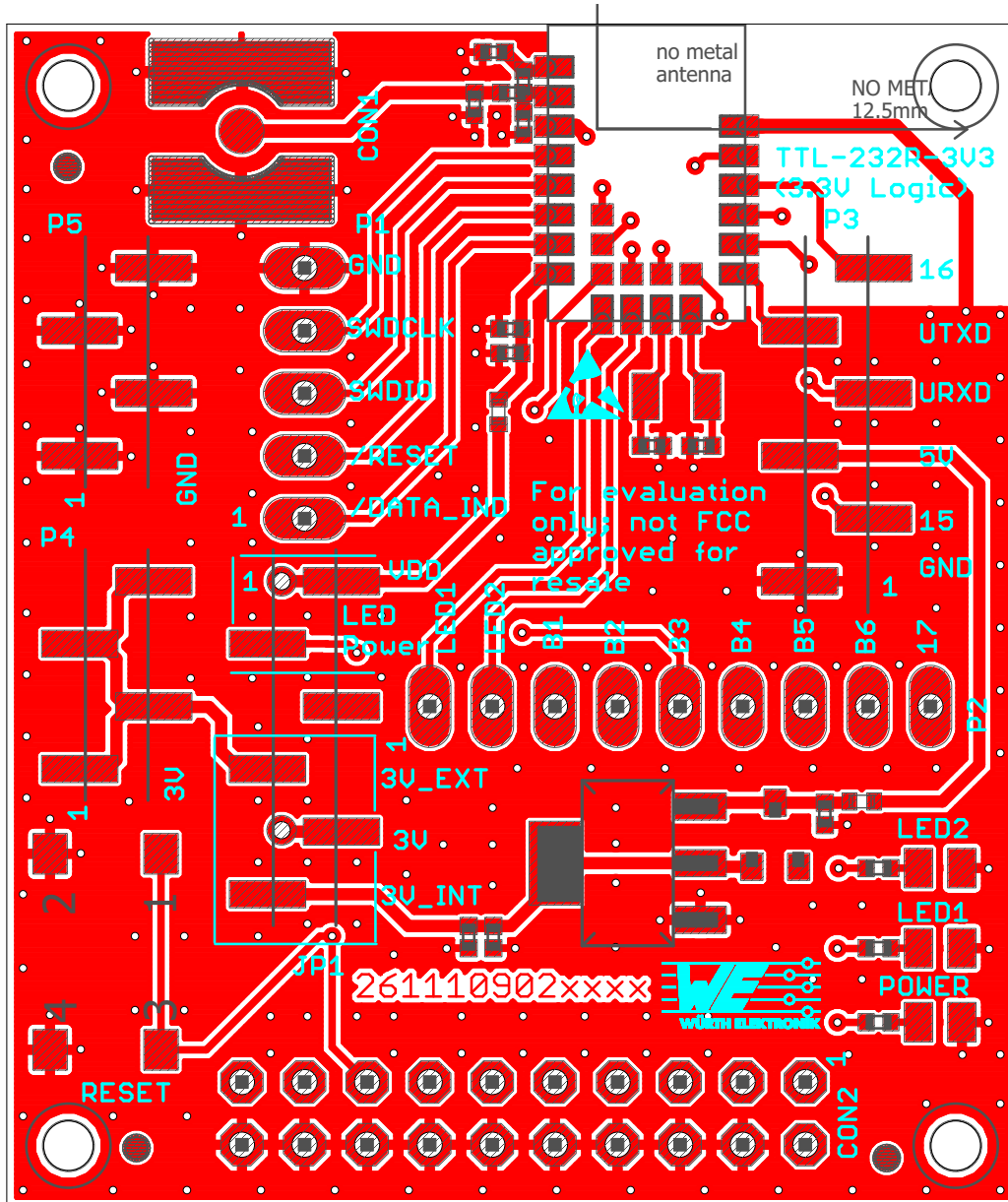

Figure 24: Reference design: Layout

11.3. Trace design

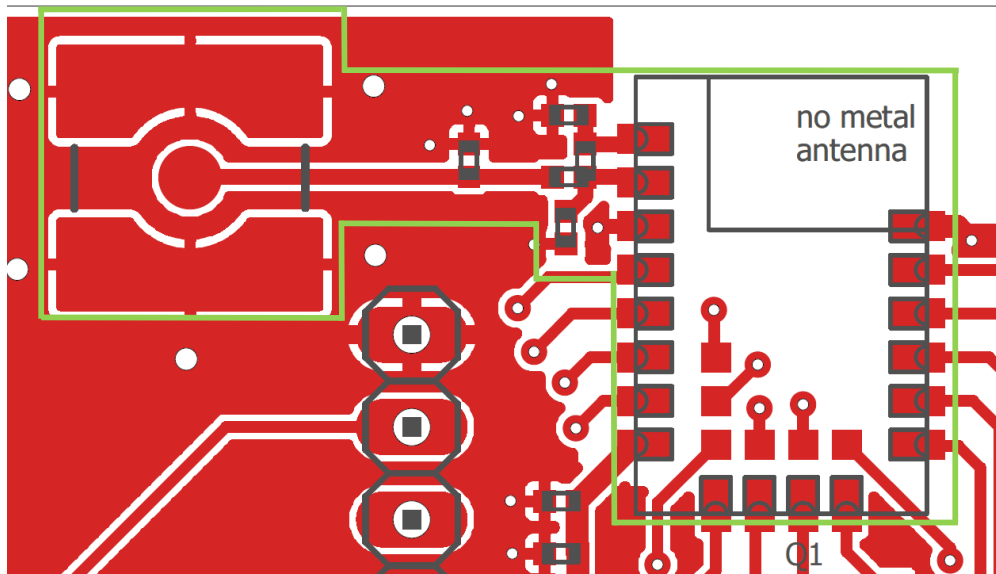

Figure 25: Trace design: Layout

Nr	Copper	Isolation
1	0.035mm	10mil
2	0.018mm	1mm
15	0.018mm	10mil
16	0.035mm	
Gesamt: 1.614mm		

Figure 26: Reference design: Stack-up

- Top layer is used for routing, filled with ground plane except area under the module and antenna free area.
- Second layer is filled with ground plane, except the antenna free area.
- Third layer is the supply layer, except antenna free area. Some routing is allowed, not dividing the supply layer into many or too small parts.
- Bottom layer is used for routing and filled with ground.



To reference to the Würth Elektronik eiSos' FCC ID it is mandatory to use the trace design.

The RF pin of module can be coupled to on-board PCB antenna or an external antenna. Two variants of the Thetis-I are certified:

- For the on-board PCB antenna: 22 pF shall be assembled on C2.
 - If additional tuning is needed in the end application, C8 and C12 can be assembled.
 - The exact values of C8 and C12 shall be specified in the end application corresponding to the individual need.

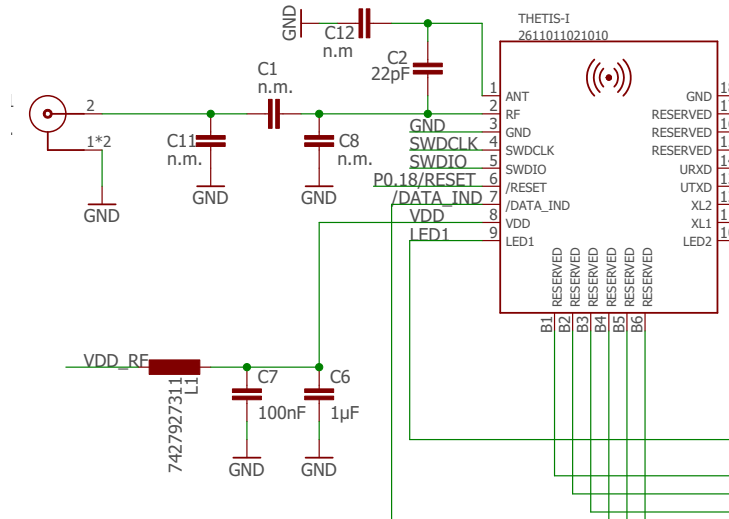

Figure 27: Trace design for on-board PCB antenna

- For the external antenna: 22pF shall be assembled on C1.
 - If additional tuning is needed in the end application, C8 and C11 can be assembled.
 - The exact values of C8 and C11 shall be specified in the end application corresponding to the individual need.

12. Manufacturing information

12.1. Moisture sensitivity level

This wireless connectivity product is categorized as JEDEC Moisture Sensitivity Level 3 (MSL3), which requires special handling.

More information regarding the MSL requirements can be found in the IPC/JEDEC J-STD-020 standard on www.jedec.org.

More information about the handling, picking, shipping and the usage of moisture/reflow and/or process sensitive products can be found in the IPC/JEDEC J-STD-033 standard on www.jedec.org.

12.2. Soldering

12.2.1. Reflow soldering

Attention must be paid on the thickness of the solder resist between the host PCB top side and the modules bottom side. Only lead-free assembly is recommended according to JEDEC J-STD020.

Profile feature		Value
Preheat temperature Min	$T_{S \text{ Min}}$	150 °C
Preheat temperature Max	$T_{S \text{ Max}}$	200 °C
Preheat time from $T_{S \text{ Min}}$ to $T_{S \text{ Max}}$	t_S	60 - 120 seconds
Ramp-up rate (T_L to T_P)		3 °C / second max.
Liquidous temperature	T_L	217 °C
Time t_L maintained above T_L	t_L	60 - 150 seconds
Peak package body temperature	T_P	see table below
Time within 5 °C of actual peak temperature	t_P	20 - 30 seconds
Ramp-down Rate (T_P to T_L)		6 °C / second max.
Time 20 °C to T_P		8 minutes max.

Table 11: Classification reflow soldering profile, Note: refer to IPC/JEDEC J-STD-020E

Package thickness	Volume mm ³ <350	Volume mm ³ 350-2000	Volume mm ³ >2000
< 1.6 mm	260 °C	260 °C	260 °C
1.6 mm - 2.5 mm	260 °C	250 °C	245 °C
> 2.5 mm	250 °C	245 °C	245 °C

Table 12: Package classification reflow temperature, PB-free assembly, Note: refer to IPC/-JEDEC J-STD-020E

It is recommended to solder this module on the last reflow cycle of the PCB. For solder paste use a LFM-48W or Indium based SAC 305 alloy (Sn 96.5 / Ag 3.0 / Cu 0.5 / Indium 8.9HF / Type 3 / 89%) type 3 or higher.

The reflow profile must be adjusted based on the thermal mass of the entire populated PCB, heat transfer efficiency of the reflow oven and the specific type of solder paste used. Based on the specific process and PCB layout the optimal soldering profile must be adjusted and verified. Other soldering methods (e.g. vapor phase) have not been verified and have to be validated by the customer at their own risk. Rework is not recommended.

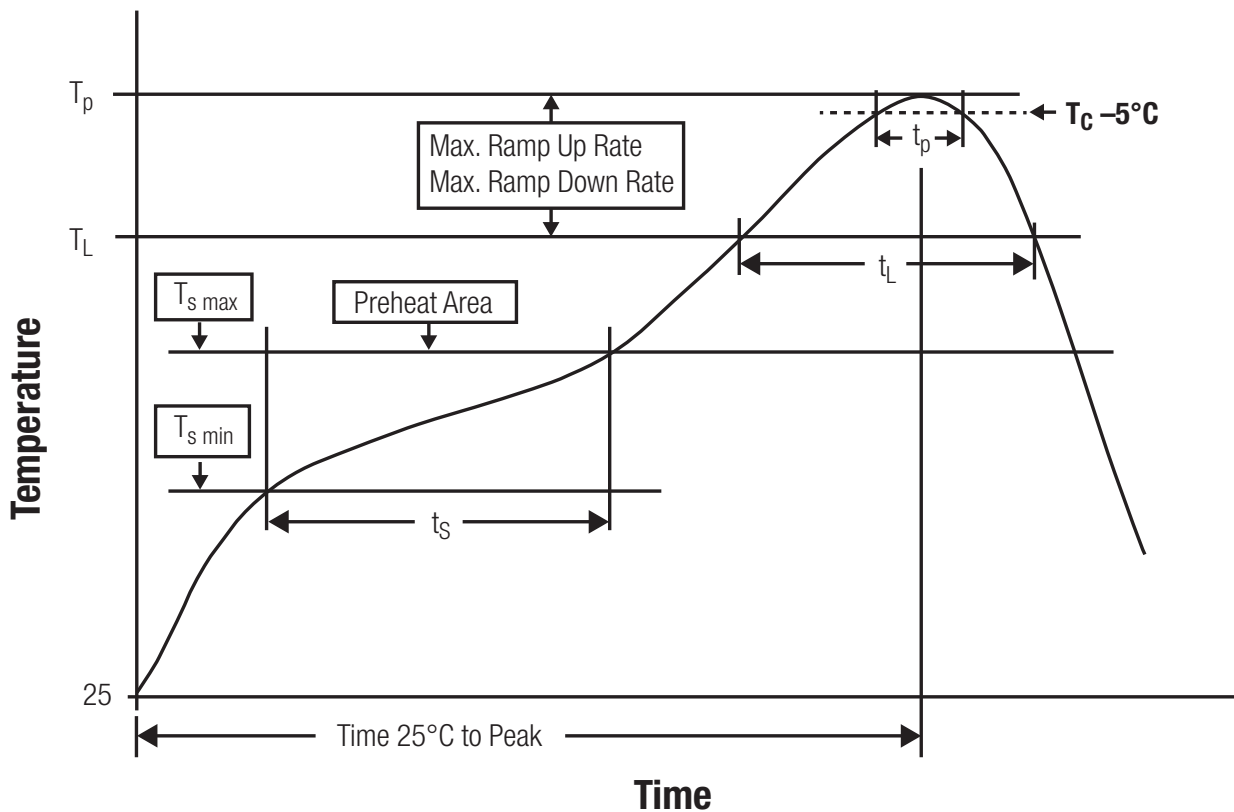

Figure 29: Reflow soldering profile

After reflow soldering, visually inspect the board to confirm proper alignment

12.2.2. Cleaning

Do not clean the product. Any residue cannot be easily removed by washing. Use a "no clean" soldering paste and do not clean the board after soldering.

- Do not clean the product with water. Capillary effects can draw water into the gap between the host PCB and the module, absorbing water underneath it. If water is trapped inside, it may short-circuit adjoining pads. The water may also destroy the label and ink-jet printed text on it.
- Cleaning processes using alcohol or other organic solvents may draw solder flux residues into the housing, which won't be detected in a post-wash inspection. The solvent may also destroy the label and ink-jet printed text on it.
- Do not use ultrasonic cleaning as it will permanently damage the part, particularly the crystal oscillators.

12.2.3. Potting and coating

- If the product is potted in the customer application, the potting material might shrink or expand during and after hardening. Shrinking could lead to an incomplete seal, allowing contaminants into the component. Expansion could damage components. We recommend a manual inspection after potting to avoid these effects.
- Conformal coating or potting results in loss of warranty.
- The RF shield will not protect the part from low-viscosity coatings and potting. An undefined amount of coating and potting will enter inside the shielding.
- Conformal coating and potting will influence the parts of the radio front end and consequently influence the radio performance.
- Potting will influence the temperature behaviour of the device. This might be critical for components with high power.

12.2.4. Other notations

- Do not attempt to improve the grounding by forming metal strips directly to the EMI covers or soldering on ground cables, as it may damage the part and will void the warranty.
- Always solder every pad to the host PCB even if some are unused, to improve the mechanical strength of the module.
- The part is sensitive to ultrasonic waves, as such do not use ultrasonic cleaning, welding or other processing. Any ultrasonic processing will void the warranty.

12.3. ESD handling

This product is highly sensitive to electrostatic discharge (ESD). As such, always use proper ESD precautions when handling. Make sure to handle the part properly throughout all stages of production, including on the host PCB where the module is installed. For ESD ratings, refer to the module series' maximum ESD section. For more information, refer to the relevant chapter 2. Failing to follow the aforementioned recommendations can result in severe damage to the part.

- the first contact point when handling the PCB is always between the local GND and the host PCB GND, unless there is a galvanic coupling between the local GND (for example work table) and the host PCB GND.
- Before assembling an antenna patch, connect the grounds.
- While handling the RF pin, avoid contact with any charged capacitors and be careful when contacting any materials that can develop charges (for example coaxial cable with around 50-80 pF/m, patch antenna with around 10 pF, soldering iron etc.)
- Do not touch any exposed area of the antenna to avoid electrostatic discharge. Do not let the antenna area be touched in a non ESD-safe manner.
- When soldering, use an ESD-safe soldering iron.

12.4. Safety recommendations

It is your duty to ensure that the product is allowed to be used in the destination country and within the required environment. Usage of the product can be dangerous and must be tested and verified by the end user. Be especially careful of:

- Use in areas with risk of explosion (for example oil refineries, gas stations).
- Use in areas such as airports, aircraft, hospitals, etc., where the product may interfere with other electronic components.

It is the customer's responsibility to ensure compliance with all applicable legal, regulatory and safety-related requirements as well as applicable environmental regulations. Disassembling the product is not allowed. Evidence of tampering will void the warranty.

- Compliance with the instructions in the product manual is recommended for correct product set-up.
- The product must be provided with a consolidated voltage source. The wiring must meet all applicable fire and security prevention standards.
- Handle with care. Avoid touching the pins as there could be ESD damage.

Be careful when working with any external components. When in doubt consult the technical documentation and relevant standards. Always use an antenna with the proper characteristics.



Würth Elektronik eiSos radio modules with high output power of up to 500 mW, as for example the radio module Thebe-II, generate a high amount of warmth while transmitting. The manufacturer of the end device must take care of potentially necessary actions for his application.

13. Physical specifications

13.1. Dimensions

Dimensions
12 x 8 x 2 mm

Table 13: Dimensions

13.2. Weight

Weight
<1g

Table 14: Weight

13.3. Module drawing

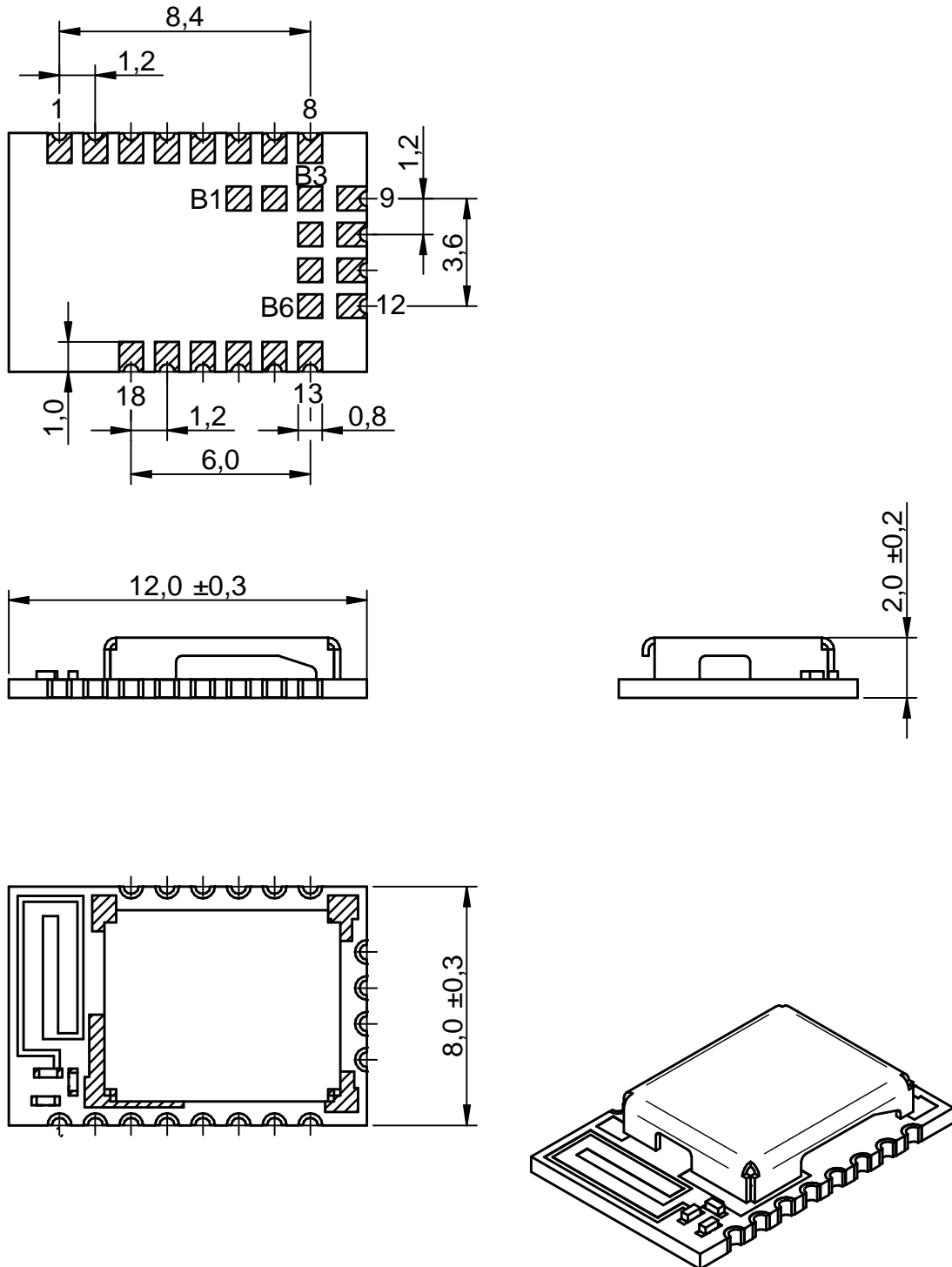

Figure 30: Module dimensions [mm]

14. Marking

14.1. Lot number

The 15 digit lot number is printed in numerical digits as well as in form of a machine readable bar code. It is divided into 5 blocks as shown in the following picture and can be translated according to the following table.

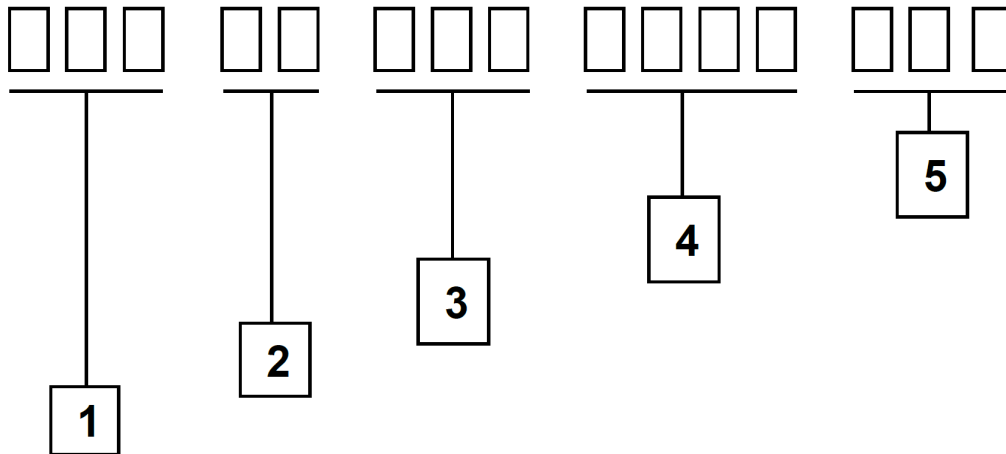

Figure 32: Lot number structure

Block	Information	Example(s)
1	eiSos internal, 3 digits	439
2	eiSos internal, 2 digits	01
3	Hardware version, 3 digits	V2.4 = 024, V12.2 = 122
4	Date code, 4 digits	1703 = week 03 in year 2017, 1816 = week 16 in year 2018
5	Firmware version, 3 digits	V3.2 = 302, V5.13 = 513

Table 15: Lot number details

As the user can perform a firmware update the printed lot number only shows the factory delivery state. The currently installed firmware can be requested from the module using the corresponding product specific command. The firmware version as well as the hardware version are restricted to show only major and minor version not the patch identifier.

14.2. General labeling information

The module labels may include the following fields:

- Manufacturer identification WE, Würth Elektronik or Würth Elektronik eiSos
- WE Order Code and/or article alias
- Serial number or MAC address
- Certification identifiers (CE, FCC ID, IC, TELEC,...)
- Bar code or 2D code containing the serial number or MAC address

If the module is using a serial Number, this serial number includes the product ID (PID) and an 6 digit number. The 6 rightmost digits represent the 6 digit number, followed by the product ID (2 or 3 digits). Some labels indicate the product ID with a "." as marker in-between the 2 fields. The PID and the 6 digit number form together a unique serial number for any wireless connectivity product.

In case of small labels, the 3 byte manufacturer identifier (0x0018DA) of the MAC address is not printed on the labels. The 3 byte counter printed on the label can be used with this 0018DA to produce the full MAC address by appending the counter after the manufacturer identifier.

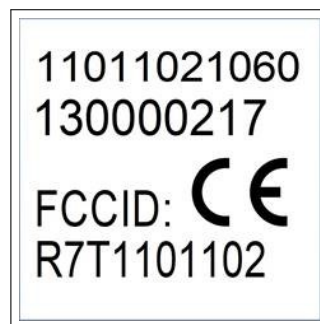

Figure 33: Label of the Thetis-I

15. Information for explosion protection

In case the end product should be used in explosion protection areas the following information can be used:

- The module itself is unfused.
- The maximum output power of the module is 6 dBm for external antenna and 4 dBm for internal antenna.
- The total capacitance of all capacitors is 7.2 μF .
- The total inductance of all inductors is 10.025 μH .
- A DC/DC regulator is included in the chipset and used to obtain low power functionality.

16. References

- [1] Wirepas. Wirepas Mesh Dual-MCU API Reference Manual, WP-RM-100, version 5.1A. <https://www.we-online.com/man-wirepas-1>.
- [2] Würth Elektronik. Thetis-I Evaluation Kit. <https://www.we-online.com/EVAL-Wirepas>.
- [3] Würth Elektronik. Thetis-I Evaluation Kit user manual. <https://www.we-online.de/katalog/de/manual/2611019021011>.
- [4] Würth Elektronik. Wirepas Commander PC tool. <https://www.we-online.com/Wirepas-Commander>.

17. Regulatory compliance information

17.1. Important notice EU

The use of RF frequencies is limited by national regulations. The Thetis-I has been designed to comply with the RED directive 2014/53/EU of the European Union (EU).

The Thetis-I can be operated without notification and free of charge in the area of the European Union. However, according to the RED directive, restrictions (e.g. in terms of duty cycle or maximum allowed RF power) may apply.



Since the module itself is not fused the voltage supply shall be fed from a power source which is class PS2 according to EN 62368-1.

17.2. Important notice FCC

The use of RF frequencies is limited by national regulations. The Thetis-I has been designed to comply with the FCC Part 15.

The Thetis-I can be operated without notification and free of charge in the area of the United States of America. However, according to the FCC Part 15, restrictions (e.g. in terms of maximum allowed RF power and antenna) may apply.

17.3. Conformity assessment of the final product

The Thetis-I is a subassembly. It is designed to be embedded into other products (products incorporating the Thetis-I are henceforward referred to as "final products").

It is the responsibility of the manufacturer of the final product to ensure that the final product is in compliance with the essential requirements of the underlying national radio regulations.

The conformity assessment of the subassembly Thetis-I carried out by Würth Elektronik eiSos does not replace the required conformity assessment of the final product.

17.4. Exemption clause

Relevant regulation requirements are subject to change. Würth Elektronik eiSos does not guarantee the accuracy of the before mentioned information. Directives, technical standards, procedural descriptions and the like may be interpreted differently by the national authorities. Equally, the national laws and restrictions may vary with the country. In case of doubt or uncertainty, we recommend that you consult with the authorities or official certification organizations of the relevant countries. Würth Elektronik eiSos is exempt from any responsibilities or liabilities related to regulatory compliance.

Notwithstanding the above, Würth Elektronik eiSos makes no representations and warranties of any kind related to their accuracy, correctness, completeness and/or usability for customer applications. No responsibility is assumed for inaccuracies or incompleteness.

17.5. EU Declaration of conformity



EU DECLARATION OF CONFORMITY

Radio equipment: 2611011021010

The manufacturer: Würth Elektronik eiSos GmbH & Co. KG
Max-Eyth-Straße 1
74638 Waldenburg

This declaration of conformity is issued under the sole responsibility of the manufacturer.

Object of the declaration: 2611011021010

The object of the declaration described above is in conformity with the relevant Union harmonisation legislation Directive 2014/53/EU and 2011/65/EU with its amending Annex II EU 2015/863 . Following harmonised norms or technical specifications have been applied:

EN 300 328 V2.2.2 (2019-07)
EN 301 489-1 V2.2.3 (2019-11)
EN 301 489-17 V3.2.4 (2020-09)
EN 62479 : 2010
EN 62368-1:2014 + AC:2015 +A11:2019

i.A. G. Exlerdt

Trier, 8th of February 2021

Place and date of issue

**EU DECLARATION OF CONFORMITY****Radio equipment:** 2611011021110**The manufacturer:** Würth Elektronik eiSos GmbH & Co. KG
Max-Eyth-Straße 1
74638 Waldenburg

This declaration of conformity is issued under the sole responsibility of the manufacturer.

Object of the declaration: 2611011021110

The object of the declaration described above is in conformity with the relevant Union harmonisation legislation Directive 2014/53/EU and 2011/65/EU with its amending Annex II EU 2015/863 . Following harmonised norms or technical specifications have been applied:

EN 300 328 V2.2.2 (2019-07)
EN 301 489-1 V2.2.3 (2019-11)
EN 301 489-17 V3.2.4 (2020-09)
EN 62479 : 2010
EN 62368-1:2014 + AC:2015 +A11:2019

i.A. G. Exler

Trier, 10th of August 2022
Place and date of issue

17.6. UK Declaration of conformity



DECLARATION OF CONFORMITY

Product:	Thetis-I Radio Module
Model/type:	2611011021010
The manufacturer:	Würth Elektronik eiSos GmbH & Co. KG Max-Eyth-Straße 1 74638 Waldenburg
The importer:	Würth Electronics UK Limited 8th Floor, 8 Exchange Quay, Salford Quays Manchester GB - M5 3EJ

This declaration of conformity is issued under the sole responsibility of the manufacturer.

Object of the declaration: 2611011021010

The object of the declaration described above is in conformity with the relevant UK Statutory Instruments: The Radio Equipment Regulations 2017 (S.I. 2017 No. 1206) & The Restriction of the Use of Certain Hazardous Substances in Electrical and Electronic Equipment Regulations 2012 (S.I. 2012 No.3032) .

References to the relevant designated standards used or references to the other technical specifications in relation to which conformity is declared:

EN 300 328 V2.2.2 (2019-07)
EN 301 489-1 V2.2.3 (2019-11)
EN 301 489-17 V3.2.4 (2020-09)
EN 62479 : 2010
EN 62368-1:2014 + AC:2015 +A11:2019

i.A. G. Eckhardt

Gudrun Eckhardt, Teamleader Hardware Development, Trier, 28th of April 2023
Name, Function, Place and date of issue

**DECLARATION OF CONFORMITY**

Product:	Thetis-I Radio Module
Model/type:	2611011021110
The manufacturer:	Würth Elektronik eiSos GmbH & Co. KG Max-Eyth-Straße 1 74638 Waldenburg
The importer:	Würth Electronics UK Limited 8th Floor, 8 Exchange Quay, Salford Quays Manchester GB - M5 3EJ

This declaration of conformity is issued under the sole responsibility of the manufacturer.

Object of the declaration: 2611011021110

The object of the declaration described above is in conformity with the relevant UK Statutory Instruments: The Radio Equipment Regulations 2017 (S.I. 2017 No. 1206) & The Restriction of the Use of Certain Hazardous Substances in Electrical and Electronic Equipment Regulations 2012 (S.I. 2012 No.3032) .

References to the relevant designated standards used or references to the other technical specifications in relation to which conformity is declared:

EN 300 328 V2.2.2 (2019-07)
EN 301 489-1 V2.2.3 (2019-11)
EN 301 489-17 V3.2.4 (2020-09)
EN 62479 : 2010
EN 62368-1:2014 + AC:2015 +A11:2019

i.A. G. Eckhardt

Gudrun Eckhardt, Teamleader Hardware Development, Trier, 28th of April 2023
Name, Function, Place and date of issue

17.7. FCC Compliance Statement (US)

FCC ID: R7T1101102

This device complies with Part 15 of the FCC Rules.

Operation is subject to the following two conditions:

- (1) this device may not cause harmful interference, and
 - (2) this device must accept any interference received, including interference that may cause undesired operation.
- (FCC 15.19)

Modifications (FCC 15.21)

Caution: Changes or modifications for this equipment not expressly approved by Würth Elektronik eiSos may void the FCC authorization to operate this equipment.

17.7.1. FCC certificate



TCB
TCB

GRANT OF EQUIPMENT AUTHORIZATION
 Certification
 Issued Under the Authority of the
 Federal Communications Commission
 By:

Telefication B.V.
 Edisonstraat 12a
 Zevenaar, NL-6902 PK
 Netherlands

Date of Grant: 11/27/2019

 Application Dated: 11/06/2019

Wuerth Elektronik eiSos GmbH & Co KG
 Max-Eyth-Strasse 1
 Waldenburg, 74638
 Germany

Attention: Gudrun Eckhardt, Manager

NOT TRANSFERABLE
 EQUIPMENT AUTHORIZATION is hereby issued to the named GRANTEE, and is VALID ONLY for the equipment identified hereon for use under the Commission's Rules and Regulations listed below.

FCC IDENTIFIER: R7T1101102
 Name of Grantee: Wuerth Elektronik eiSos GmbH & Co KG
 Equipment Class: Digital Transmission System
 Notes: Radio module HVIN 1101102
 Modular Type: Single Modular

Grant Notes	FCC Rule Parts	Frequency Range (MHz)	Output Watts	Frequency Emission Tolerance Designator
CC	15C	2402.0 - 2480.0	0.0042	

Output power listed is conducted. Single modular approval for portable RF Exposure conditions. Approval is limited to OEM installations only. OEM integrators must be provided with antenna installation instructions. OEM integrators and end users must be provided with transmitter operating conditions for satisfying RF exposure compliance. This grant is valid only when the device is sold to OEM integrators and the OEM integrators are instructed to ensure that the end user has no manual instructions to remove or install the device. Only those antenna(s) tested with the device or similar antenna(s) with equal or lesser gain may be used with this transmitter.

CC: This device is certified pursuant to two different Part 15 rules sections.

Certificate No.:
192180963/AA/00

Gürhan Vural
Product Assessor



Figure 34: FCC certificate

17.8. IC Compliance Statement (Canada)

Certification Number: 5136A-1101102

HVIN: 1101102

This device complies with Industry Canada licence-exempt RSS standard(s). Operation is subject to the following two conditions: (1) this device may not cause harmful interference, and (2) this device must accept any interference received, including interference that may cause undesired operation.

Le présent appareil est conforme aux CNR d'Industrie Canada applicables aux appareils radio exempts de licence. L'exploitation est autorisée aux deux conditions suivantes : (1) l'appareil ne doit pas produire de brouillage, et (2) l'utilisateur de l'appareil doit accepter tout brouillage radioélectrique subi, même si le brouillage est susceptible d'en compromettre le fonctionnement.

17.8.1. IC certificate

telefication bv
The Netherlands
Chamber of Commerce
51565536
www.telefication.com



telefication

TECHNICAL ACCEPTANCE CERTIFICATE	CERTIFICAT D'ACCEPTABILITÉ TECHNIQUE				
CERTIFICATION No. No. DE CERTIFICATION	5136A-1101102				
TELEFICATION No. No. DE TELEFICATION	192170345/AA/00				
TEST SITE No. No. DE LABORATOIRE	3699A				
ISSUED TO DÉLIVRÉ À					
TYPE OF EQUIPMENT GENRE DE MATÉRIEL	SPREAD SPECTRUM DEVICE (2400-2483.5 MHz)				
TRADE NAME AND MODEL MARQUE ET MODÈLE	Würth Elektronik eiSos GmbH & Co. KG / 1101102				
CERTIFIED TO CERTIFIÉ SELON LE	<table border="0" style="font-size: 8px;"> <tr> <td>SPECIFICATION CAHIER DES CHARGES</td> <td>RSS-102 RSS-247</td> <td>ISSUE EDITION</td> <td>5 2</td> </tr> </table>	SPECIFICATION CAHIER DES CHARGES	RSS-102 RSS-247	ISSUE EDITION	5 2
SPECIFICATION CAHIER DES CHARGES	RSS-102 RSS-247	ISSUE EDITION	5 2		

Certification of equipment means only that the equipment has met the requirements of the above-noted specification. Licence applications, where applicable to use certified equipment, are acted on accordingly by the ISSED issuing office and will depend on the existing radio environment, service and location of operation. This certificate is issued on condition that the holder complies and will continue to comply with the requirements and procedures issued by ISSED. The equipment for which this certificate is issued shall not be manufactured, imported, distributed, leased, offered for sale or sold unless the equipment complies with the applicable technical specifications and procedures issued by ISSED.

La certification du matériel signifie seulement que le matériel a satisfait aux exigences de la norme indiquée ci-dessus. Les demandes de licences nécessaires pour l'utilisation du matériel certifié sont traitées en conséquence par le bureau de délivrance d'ISSE et dépendent des conditions radio ambiantes, du service et de l'emplacement d'exploitation. Le présent certificat est délivré à la condition que le titulaire satisfasse et continue de satisfaire aux exigences et aux procédures d'ISSE. Le matériel à l'égard duquel le présent certificat est délivré ne doit pas être fabriqué, importé, distribué, loué, mis en vente ou vendu à moins d'être conforme aux procédures et aux spécifications techniques applicables publiées par ISSE.

ISSUED BY TELEFICATION BV (NL0001), RECOGNIZED CERTIFICATION BODY BY INNOVATION, SCIENCE AND ECONOMIC DEVELOPMENT CANADA
DÉLIVRÉ PAR TELEFICATION BV (NL0001), ORGANISME DE CERTIFICATION RECONNU PAR INNOVATION, SCIENCES ET DÉVELOPPEMENT ÉCONOMIQUE CANADA

*I hereby attest that the subject equipment was tested and found in compliance with the above-noted specification.
J'atteste, par la présente, que le matériel a fait l'objet d'essai et a été jugé conforme à la spécification ci-dessus*

DATE 02 Dec 2019 BY

This certificate has one annex.

Gürhan Vural
Product Assessor







laboratory



certification



approvals

Figure 35: IC certificate

17.9. FCC and IC requirements to OEM integrators

This module has been granted modular approval. OEM integrators for host products may use the module in their final products without additional FCC/IC (Industry Canada) certification if they meet the following conditions. Otherwise, additional FCC/IC approvals must be obtained. The host product with the module installed must be evaluated for simultaneous transmission requirements.

- The users manual for the host product must clearly indicate the operating requirements and conditions that must be observed to ensure compliance with current FCC/IC RF exposure guidelines.
- To comply with FCC/IC regulations limiting both maximum RF output power and human exposure to RF radiation, the maximum antenna gain including cable loss in a mobile-only exposure condition must not exceed 6dBi.
- A label must be affixed to the outside of the host product with the following statements:
This device contains FCCID: R7T1101102
This equipment contains equipment certified under ICID: 5136A-1101102
- The final host / module combination may also need to be evaluated against the FCC Part 15B criteria for unintentional radiators in order to be properly authorized for operation as a Part 15 digital device.
- If the final host / module combination is intended for use as a portable device (see classifications below) the host manufacturer is responsible for separate approvals for the SAR requirements from FCC Part 2.1093 and RSS-102.

OEM requirements:

The OEM must ensure that the following conditions are met.

- The Thetis-I will be used at a distance of at least 10 mm.
- End users of products, which contain the module, must not have the ability to alter the firmware that governs the operation of the module. The agency grant is valid only when the module is incorporated into a final product by OEM integrators.
- The end-user must not be provided with instructions to remove, adjust or install the module.
- The Original Equipment Manufacturer (OEM) must ensure that FCC labeling requirements are met. This includes a clearly visible label on the outside of the final product. Attaching a label to a removable portion of the final product, such as a battery cover, is not permitted.
- The label must include the following text:
Contains FCC ID: R7T1101102
The enclosed device complies with Part 15 of the FCC Rules. Operation is subject to the following two conditions:
(i.) this device may not cause harmful interference and
(ii.) this device must accept any interference received, including interference that may

cause undesired operation.

When the device is so small or for such use that it is not practicable to place the statement above on it, the information required by this paragraph shall be placed in a prominent location in the instruction manual or pamphlet supplied to the user or, alternatively, shall be placed on the container in which the device is marketed. However, the FCC identifier or the unique identifier, as appropriate, must be displayed on the device.

- The user manual for the end product must also contain the text given above.
 - Changes or modifications not expressly approved could void the user’s authority to operate the equipment.
 - The OEM must ensure that timing requirements according to 47 CFR 15.231(a-c) are met.
 - The OEM must sign the OEM Modular Approval Agreement.
 - The module must be used with only the following approved antenna(s).

17.9.1. Pre-certified antennas

The Thetis-I is pre-certified with the following antennas.

Product	Certified antenna
Thetis-I (2611011021010)	PCB antenna included in the Thetis-I
Thetis-I (2611011021110)	PCB antenna included in the Thetis-I

17.10. ETA-WPC (India)

Registration No: ETA-SD-20230302020 Date: 06-04-2023

The Thetis-I complies with the provisions on the Equipment Type Approval WPC Wing for India.

17.10.1. ETA-WPC certificate

 सत्यमेव जयते		Government of India Ministry of Communications Department of Telecommunications WPC Wing Sanchar Bhawan, New Delhi-110001.
[Generation of Equipment Type Approval (ETA) through self-declaration issued under O.M. No. ETA-WPC /Policy/2018-19 dated 26 February, 2019].		
THIS ETA IS ISSUED FOR A SINGLE MODEL WITH MODEL NAME <u>Thetis-I</u>		
Registration No: ETA-SD-20230302020		Date: 06-04-2023
D). Details of Applicant and Parameters of Equipment:		
1.	Name & Address of the first Applicant. (Indian Manufacturer/ Authorised Indian representative for foreign manufacturer)	WURTH ELECTRONICS SERVICES INDIA PRIVATE LIMITED, Ground and 1st Floor, No. 3, Prestige Sterling Square, Madras Bank Road, Next to Airlines Hotel, Bangalore, Bengaluru Bangalore Urban, Karnataka, 560001, Bangalore Urban,KARNATAKA,560001
2.	Equipment category	2.4GHz Wirepas Mesh Module
3.	Make	Wurth Elektronik eiSos GmbH & Co. KG,Germany
4.	Model	Thetis-I
5.	Frequency range(s) of Equipment	1. 2402-2480 MHz
6.	Max output power/Field strength/PSD	1. E.I.R.P. (dBm). 4

1 / 2

Figure 36: ETA-WPC certificate page 1

7.	Applicable Gazette Notification(s)	1. 45 (E) Dated 28-01-2005	
8.	RF Test Report details:-		
	Name&Address /Country of accredited laboratory issuing the RF test report	Accreditation Certificate Reference/Number	Test Report No. and Date
	7layers GmbH & Borsigstrasse 11 40880 Ratingen Germany	D-PL-12140-01-03	MDE_WUERTH_1901_RADIO01 & 15-10-2019

II). Terms and Conditions

- (i). This certificate will not be valid in case any change in the above parameters and not conforming to the Gazette Notification mentioned in sl.no 7 above.
- (ii). Use of such equipment has been exempted from licensing requirement vide Gazette Notification mentioned in sl. no. 7, on Non-interference,Non-protectionand sharing (non-exclusive) basis.
- (iii). Use of such equipment in case not conforming to above notification will require a specific wireless operating license, as applicable from this Ministry.
- (iv). Field units of WPC Wing reserve the right for sample check/audit carried out for the purpose of RF analysis/spectrum monitoring in view to avoid interference to other wireless users and ensure compliance of technical parameters mentioned in sl no. 5,6&7.
- (v). This certificate is valid only for equipment which are exempted from import licensing requirements as per the Import Policy of DGFT and for import of such device, a self-declaration based, system generated (Saralsanchar) Import undertaking/ permission is required.
- (vi). The applicant is liable for prosecution under Indian Law in case of any wrong declaration/ submission of ingenuine RF test report(s) for issue of ETA through Self-Declaration.

Note:

- 1. Once ETA through self-declaration is generated for a model, subsequently it may be utilized by other person(s) for import/usage purpose in India.
- 2. The importers of above model shall comply with other import related requirements, if any, with Customs.

This is Self-generated certificate. Hence, no signature is required. It may be downloaded/verified from the website <https://saralsanchar.gov.in>.

Figure 37: ETA-WPC certificate page 2

18. Important notes

The following conditions apply to all goods within the wireless connectivity product range of Würth Elektronik eiSos GmbH & Co. KG:

18.1. General customer responsibility

Some goods within the product range of Würth Elektronik eiSos GmbH & Co. KG contain statements regarding general suitability for certain application areas. These statements about suitability are based on our knowledge and experience of typical requirements concerning the areas, serve as general guidance and cannot be estimated as binding statements about the suitability for a customer application. The responsibility for the applicability and use in a particular customer design is always solely within the authority of the customer. Due to this fact, it is up to the customer to evaluate, where appropriate to investigate and to decide whether the device with the specific product characteristics described in the product specification is valid and suitable for the respective customer application or not. Accordingly, the customer is cautioned to verify that the documentation is current before placing orders.

18.2. Customer responsibility related to specific, in particular safety-relevant applications

It has to be clearly pointed out that the possibility of a malfunction of electronic components or failure before the end of the usual lifetime cannot be completely eliminated in the current state of the art, even if the products are operated within the range of the specifications. The same statement is valid for all software sourcecode and firmware parts contained in or used with or for products in the wireless connectivity and sensor product range of Würth Elektronik eiSos GmbH & Co. KG. In certain customer applications requiring a high level of safety and especially in customer applications in which the malfunction or failure of an electronic component could endanger human life or health, it must be ensured by most advanced technological aid of suitable design of the customer application that no injury or damage is caused to third parties in the event of malfunction or failure of an electronic component.

18.3. Best care and attention

Any product-specific data sheets, manuals, application notes, PCN's, warnings and cautions must be strictly observed in the most recent versions and matching to the products firmware revisions. This documents can be downloaded from the product specific sections on the wireless connectivity homepage.

18.4. Customer support for product specifications

Some products within the product range may contain substances, which are subject to restrictions in certain jurisdictions in order to serve specific technical requirements. Necessary information is available on request. In this case, the field sales engineer or the internal sales person in charge should be contacted who will be happy to support in this matter.

18.5. Product improvements

Due to constant product improvement, product specifications may change from time to time. As a standard reporting procedure of the Product Change Notification (PCN) according to the JEDEC-Standard, we inform about major changes. In case of further queries regarding the PCN, the field sales engineer, the internal sales person or the technical support team in charge should be contacted. The basic responsibility of the customer as per section 18.1 and 18.2 remains unaffected. All wireless connectivity module driver software "wireless connectivity SDK" and its source codes as well as all PC software tools are not subject to the Product Change Notification information process.

18.6. Product life cycle

Due to technical progress and economical evaluation we also reserve the right to discontinue production and delivery of products. As a standard reporting procedure of the Product Termination Notification (PTN) according to the JEDEC-Standard we will inform at an early stage about inevitable product discontinuance. According to this, we cannot ensure that all products within our product range will always be available. Therefore, it needs to be verified with the field sales engineer or the internal sales person in charge about the current product availability expectancy before or when the product for application design-in disposal is considered. The approach named above does not apply in the case of individual agreements deviating from the foregoing for customer-specific products.

18.7. Property rights

All the rights for contractual products produced by Würth Elektronik eiSos GmbH & Co. KG on the basis of ideas, development contracts as well as models or templates that are subject to copyright, patent or commercial protection supplied to the customer will remain with Würth Elektronik eiSos GmbH & Co. KG. Würth Elektronik eiSos GmbH & Co. KG does not warrant or represent that any license, either expressed or implied, is granted under any patent right, copyright, mask work right, or other intellectual property right relating to any combination, application, or process in which Würth Elektronik eiSos GmbH & Co. KG components or services are used.

18.8. General terms and conditions

Unless otherwise agreed in individual contracts, all orders are subject to the current version of the "General Terms and Conditions of Würth Elektronik eiSos Group", last version available at www.we-online.com.

19. Legal notice

19.1. Exclusion of liability

Würth Elektronik eiSos GmbH & Co. KG considers the information in this document to be correct at the time of publication. However, Würth Elektronik eiSos GmbH & Co. KG reserves the right to modify the information such as technical specifications or functions of its products or discontinue the production of these products or the support of one of these products without any written announcement or notification to customers. The customer must make sure that the information used corresponds to the latest published information. Würth Elektronik eiSos GmbH & Co. KG does not assume any liability for the use of its products. Würth Elektronik eiSos GmbH & Co. KG does not grant licenses for its patent rights or for any other of its intellectual property rights or third-party rights.

Notwithstanding anything above, Würth Elektronik eiSos GmbH & Co. KG makes no representations and/or warranties of any kind for the provided information related to their accuracy, correctness, completeness, usage of the products and/or usability for customer applications. Information published by Würth Elektronik eiSos GmbH & Co. KG regarding third-party products or services does not constitute a license to use such products or services or a warranty or endorsement thereof.

19.2. Suitability in customer applications

The customer bears the responsibility for compliance of systems or units, in which Würth Elektronik eiSos GmbH & Co. KG products are integrated, with applicable legal regulations. Customer acknowledges and agrees that it is solely responsible for compliance with all legal, regulatory and safety-related requirements concerning its products, and any use of Würth Elektronik eiSos GmbH & Co. KG components in its applications, notwithstanding any applications-related information or support that may be provided by Würth Elektronik eiSos GmbH & Co. KG. Customer represents and agrees that it has all the necessary expertise to create and implement safeguards which anticipate dangerous consequences of failures, monitor failures and their consequences lessen the likelihood of failures that might cause harm and take appropriate remedial actions. The customer will fully indemnify Würth Elektronik eiSos GmbH & Co. KG and its representatives against any damages arising out of the use of any Würth Elektronik eiSos GmbH & Co. KG components in safety-critical applications.

19.3. Trademarks

AMBER wireless is a registered trademark of Würth Elektronik eiSos GmbH & Co. KG. All other trademarks, registered trademarks, and product names are the exclusive property of the respective owners.

19.4. Usage restriction

Würth Elektronik eiSos GmbH & Co. KG products have been designed and developed for usage in general electronic equipment only. This product is not authorized for use in equipment

where a higher safety standard and reliability standard is especially required or where a failure of the product is reasonably expected to cause severe personal injury or death, unless the parties have executed an agreement specifically governing such use. Moreover, Würth Elektronik eiSos GmbH & Co. KG products are neither designed nor intended for use in areas such as military, aerospace, aviation, nuclear control, submarine, transportation (automotive control, train control, ship control), transportation signal, disaster prevention, medical, public information network etc. Würth Elektronik eiSos GmbH & Co. KG must be informed about the intent of such usage before the design-in stage. In addition, sufficient reliability evaluation checks for safety must be performed on every electronic component, which is used in electrical circuits that require high safety and reliability function or performance. By using Würth Elektronik eiSos GmbH & Co. KG products, the customer agrees to these terms and conditions.

20. License terms

These License terms will take effect upon the purchase and usage of the Würth Elektronik eiSos GmbH & Co. KG wireless connectivity products. You hereby agree that these license terms are applicable to the product and the incorporated software, firmware and source codes (collectively, "Software") made available by Würth Elektronik eiSos in any form, including but not limited to binary, executable or source code form.

The software included in any Würth Elektronik eiSos wireless connectivity product is purchased to you on the condition that you accept the terms and conditions of these license terms. You agree to comply with all provisions under these license terms.

20.1. Limited license

Würth Elektronik eiSos hereby grants you a limited, non-exclusive, non-transferable and royalty-free license to use the software and under the conditions that will be set forth in these license terms. You are free to use the provided software only in connection with one of the products from Würth Elektronik eiSos to the extent described in these license terms. You are entitled to change or alter the source code for the sole purpose of creating an application embedding the Würth Elektronik eiSos wireless connectivity product. The transfer of the source code to third parties is allowed to the sole extent that the source code is used by such third parties in connection with our product or another hardware provided by Würth Elektronik eiSos under strict adherence of these license terms. Würth Elektronik eiSos will not assume any liability for the usage of the incorporated software and the source code. You are not entitled to transfer the source code in any form to third parties without prior written consent of Würth Elektronik eiSos.

You are not allowed to reproduce, translate, reverse engineer, decompile, disassemble or create derivative works of the incorporated software and the source code in whole or in part. No more extensive rights to use and exploit the products are granted to you.

20.2. Usage and obligations

The responsibility for the applicability and use of the Würth Elektronik eiSos wireless connectivity product with the incorporated firmware in a particular customer design is always solely within the authority of the customer. Due to this fact, it is up to you to evaluate and investigate, where appropriate, and to decide whether the device with the specific product characteristics described in the product specification is valid and suitable for your respective application or not.

You are responsible for using the Würth Elektronik eiSos wireless connectivity product with the incorporated firmware in compliance with all applicable product liability and product safety laws. You acknowledge to minimize the risk of loss and harm to individuals and bear the risk for failure leading to personal injury or death due to your usage of the product.

Würth Elektronik eiSos' products with the incorporated firmware are not authorized for use in safety-critical applications, or where a failure of the product is reasonably expected to cause severe personal injury or death. Moreover, Würth Elektronik eiSos' products with the incorporated firmware are neither designed nor intended for use in areas such as military, aerospace, aviation, nuclear control, submarine, transportation (automotive control, train control, ship control), transportation signal, disaster prevention, medical, public information network etc. You

shall inform Würth Elektronik eiSos about the intent of such usage before design-in stage. In certain customer applications requiring a very high level of safety and in which the malfunction or failure of an electronic component could endanger human life or health, you must ensure to have all necessary expertise in the safety and regulatory ramifications of your applications. You acknowledge and agree that you are solely responsible for all legal, regulatory and safety-related requirements concerning your products and any use of Würth Elektronik eiSos' products with the incorporated firmware in such safety-critical applications, notwithstanding any applications-related information or support that may be provided by Würth Elektronik eiSos. **YOU SHALL INDEMNIFY WÜRTH ELEKTRONIK EISOS AGAINST ANY DAMAGES ARISING OUT OF THE USE OF WÜRTH ELEKTRONIK EISOS' PRODUCTS WITH THE INCORPORATED FIRMWARE IN SUCH SAFETY-CRITICAL APPLICATIONS.**

20.3. Ownership

The incorporated firmware created by Würth Elektronik eiSos is and will remain the exclusive property of Würth Elektronik eiSos.

20.4. Firmware update(s)

You have the opportunity to request the current and actual firmware for a bought wireless connectivity product within the time of warranty. However, Würth Elektronik eiSos has no obligation to update a modules firmware in their production facilities, but can offer this as a service on request. The upload of firmware updates falls within your responsibility, e.g. via ACC or another software for firmware updates. Firmware updates will not be communicated automatically. It is within your responsibility to check the current version of a firmware in the latest version of the product manual on our website. The revision table in the product manual provides all necessary information about firmware updates. There is no right to be provided with binary files, so called "firmware images", those could be flashed through JTAG, SWD, Spi-Bi-Wire, SPI or similar interfaces.

20.5. Disclaimer of warranty

THE FIRMWARE IS PROVIDED "AS IS". YOU ACKNOWLEDGE THAT WÜRTH ELEKTRONIK EISOS MAKES NO REPRESENTATIONS AND WARRANTIES OF ANY KIND RELATED TO, BUT NOT LIMITED TO THE NON-INFRINGEMENT OF THIRD PARTIES' INTELLECTUAL PROPERTY RIGHTS OR THE MERCHANTABILITY OR FITNESS FOR YOUR INTENDED PURPOSE OR USAGE. WÜRTH ELEKTRONIK EISOS DOES NOT WARRANT OR REPRESENT THAT ANY LICENSE, EITHER EXPRESS OR IMPLIED, IS GRANTED UNDER ANY PATENT RIGHT, COPYRIGHT, MASK WORK RIGHT, OR OTHER INTELLECTUAL PROPERTY RIGHT RELATING TO ANY COMBINATION, MACHINE, OR PROCESS IN WHICH THE WÜRTH ELEKTRONIK EISOS' PRODUCT WITH THE INCORPORATED FIRMWARE IS USED. INFORMATION PUBLISHED BY WÜRTH ELEKTRONIK EISOS REGARDING THIRD-PARTY PRODUCTS OR SERVICES DOES NOT CONSTITUTE A LICENSE FROM WÜRTH ELEKTRONIK EISOS TO USE SUCH PRODUCTS OR SERVICES OR A WARRANTY OR ENDORSEMENT THEREOF.

20.6. Limitation of liability

Any liability not expressly provided by Würth Elektronik eiSos shall be disclaimed. You agree to hold us harmless from any third-party claims related to your usage of the Würth Elektronik eiSos' products with the incorporated firmware, software and source code. Würth Elektronik eiSos disclaims any liability for any alteration, development created by you or your customers as well as for any combination with other products.

20.7. Applicable law and jurisdiction

Applicable law to these license terms shall be the laws of the Federal Republic of Germany. Any dispute, claim or controversy arising out of or relating to these license terms shall be resolved and finally settled by the court competent for the location of Würth Elektronik eiSos registered office.

20.8. Severability clause

If a provision of these license terms is or becomes invalid, unenforceable or null and void, this shall not affect the remaining provisions of the terms. The parties shall replace any such provisions with new valid provisions that most closely approximate the purpose of the terms.

20.9. Miscellaneous

Würth Elektronik eiSos reserves the right at any time to change this terms at its own discretion. It is your responsibility to check at Würth Elektronik eiSos homepage for any updates. Your continued usage of the products will be deemed as the acceptance of the change.

We recommend you to be updated about the status of new firmware and software, which is available on our website or in our data sheet and manual, and to implement new software in your device where appropriate.

By ordering a product, you accept these license terms in all terms.

List of Figures

1.	Thetis-I	8
2.	Block diagram	9
3.	Radio transmitting @ 8 dBm output power, 1 Mbps radio profile, Clock = HFXO (typical)	14
4.	Pinout (top view)	17
5.	Minimal pin connections	19
6.	Setup quick start	23
7.	Open the COM port	23
8.	Configure the node	24
9.	Start the stack	24
10.	Configure the node	24
11.	Check whether a connection to the sink exists	25
12.	Transmit "Hello world" from module B	25
13.	Receive "Hello world" on module A	26
14.	Host Interface	28
15.	Message types	29
16.	Message flow	30
17.	Frame format	31
18.	Layout	38
19.	Placement of the module with integrated antenna	39
20.	Dimensioning the antenna feed line as micro strip	40
21.	2.4 GHz dipole-antenna	42
22.	LFXO mounting	43
23.	Reference design: Schematic page 1	45
24.	Reference design: Layout	46
25.	Trace design: Layout	47
26.	Reference design: Stack-up	47
27.	Trace design for on-board PCB antenna	49
28.	Trace design for external antenna connection	50
29.	Reflow soldering profile	52
30.	Module dimensions [mm]	57
31.	Footprint WE-FP-4+ [mm]	58
32.	Lot number structure	59
33.	Label of the Thetis-I	60
34.	FCC certificate	68
35.	IC certificate	69
36.	ETA-WPC certificate page 1	72
37.	ETA-WPC certificate page 2	73

List of Tables

1.	Ordering information	10
2.	Recommended operating conditions	11
3.	Absolute maximum ratings	12
4.	Power consumption for 100% transmission/reception	13

5.	Transmit and Receive Power	15
6.	Sensitivity at 1000 kbit/s data rate	15
7.	Pin characteristics for digital IO	16
8.	Pin description	18
9.	LED behaviour of the Thetis-I	27
10.	Uncoded frame	31
11.	Classification reflow soldering profile, Note: refer to IPC/JEDEC J-STD-020E	51
12.	Package classification reflow temperature, PB-free assembly, Note: refer to IPC/- JEDEC J-STD-020E	52
13.	Dimensions	56
14.	Weight	56
15.	Lot number details	59
16.	CRC Test Vectors	84

A. Additional CRC16 Information

This Annex gives an example CRC16 implementation and test vectors.

A.1. Example CRC Implementation

```
#include <stdint.h>

static const uint16_t crc_ccitt_lut[] =
{
    0x0000, 0x1021, 0x2042, 0x3063, 0x4084, 0x50a5, 0x60c6, 0x70e7, \
    0x8108, 0x9129, 0xa14a, 0xb16b, 0xc18c, 0xd1ad, 0xe1ce, 0xf1ef, \
    0x1231, 0x0210, 0x3273, 0x2252, 0x52b5, 0x4294, 0x72f7, 0x62d6, \
    0x9339, 0x8318, 0xb37b, 0xa35a, 0xd3bd, 0xc39c, 0xf3ff, 0xe3de, \
    0x2462, 0x3443, 0x0420, 0x1401, 0x64e6, 0x74c7, 0x44a4, 0x5485, \
    0xa56a, 0xb54b, 0x8528, 0x9509, 0xe5ee, 0xf5cf, 0xc5ac, 0xd58d, \
    0x3653, 0x2672, 0x1611, 0x0630, 0x76d7, 0x66f6, 0x5695, 0x46b4, \
    0xb75b, 0xa77a, 0x9719, 0x8738, 0xf7df, 0xe7fe, 0xd79d, 0xc7bc, \
    0x48c4, 0x58e5, 0x6886, 0x78a7, 0x0840, 0x1861, 0x2802, 0x3823, \
    0xc9cc, 0xd9ed, 0xe98e, 0xf9af, 0x8948, 0x9969, 0xa90a, 0xb92b, \
    0x5af5, 0x4ad4, 0x7ab7, 0x6a96, 0x1a71, 0x0a50, 0x3a33, 0x2a12, \
    0xdbfd, 0xcbdc, 0xfbbf, 0xeb9e, 0x9b79, 0x8b58, 0xbb3b, 0xab1a, \
    0x6ca6, 0x7c87, 0x4ce4, 0x5cc5, 0x2c22, 0x3c03, 0x0c60, 0x1c41, \
    0xedae, 0xfd8f, 0xcdec, 0xddcd, 0xad2a, 0xbd0b, 0x8d68, 0x9d49, \
    0x7e97, 0x6eb6, 0x5ed5, 0x4ef4, 0x3e13, 0x2e32, 0x1e51, 0x0e70, \
    0xff9f, 0xefbe, 0xdfdd, 0xcffc, 0xbf1b, 0xaf3a, 0x9f59, 0x8f78, \
    0x9188, 0x81a9, 0xb1ca, 0xa1eb, 0xd10c, 0xc12d, 0xf14e, 0xe16f, \
    0x1080, 0x00a1, 0x30c2, 0x20e3, 0x5004, 0x4025, 0x7046, 0x6067, \
    0x83b9, 0x9398, 0xa3fb, 0xb3da, 0xc33d, 0xd31c, 0xe37f, 0xf35e, \
    0x02b1, 0x1290, 0x22f3, 0x32d2, 0x4235, 0x5214, 0x6277, 0x7256, \
    0xb5ea, 0xa5cb, 0x95a8, 0x8589, 0xf56e, 0xe54f, 0xd52c, 0xc50d, \
    0x34e2, 0x24c3, 0x14a0, 0x0481, 0x7466, 0x6447, 0x5424, 0x4405, \
    0xa7db, 0xb7fa, 0x8799, 0x97b8, 0xe75f, 0xf77e, 0xc71d, 0xd73c, \
    0x26d3, 0x36f2, 0x0691, 0x16b0, 0x6657, 0x7676, 0x4615, 0x5634, \
    0xd94c, 0xc96d, 0xf90e, 0xe92f, 0x99c8, 0x89e9, 0xb98a, 0xa9ab, \
    0x5844, 0x4865, 0x7806, 0x6827, 0x18c0, 0x08e1, 0x3882, 0x28a3, \
    0xcb7d, 0xdb5c, 0xeb3f, 0xfb1e, 0x8bf9, 0x9bd8, 0xabbb, 0xbb9a, \
    0x4a75, 0x5a54, 0x6a37, 0x7a16, 0x0af1, 0x1ad0, 0x2ab3, 0x3a92, \
    0xfd2e, 0xed0f, 0xdd6c, 0xcd4d, 0xbdaa, 0xad8b, 0x9de8, 0x8dc9, \
    0x7c26, 0x6c07, 0x5c64, 0x4c45, 0x3ca2, 0x2c83, 0x1ce0, 0x0cc1, \
    0xef1f, 0xff3e, 0xcf5d, 0xdf7c, 0xaf9b, 0xbfba, 0x8fd9, 0x9ff8, \
    0x6e17, 0x7e36, 0x4e55, 0x5e74, 0x2e93, 0x3eb2, 0x0ed1, 0x1ef0 \
};

uint16_t Get_CRC16(uint8_t* buf, uint32_t len)
{
    uint16_t crc = 0xffff;
    uint8_t index;
    for (uint32_t i = 0; i < len; i++)
    {
        index = buf[i] ^ (crc >> 8);
        crc = crc_ccitt_lut[index] ^ (crc << 8);
    }
    return crc;
}
```

Code 1: Example CRC16 Implementation

A.2. CRC Test Vectors

Input data	Data length	Resulting CRC (LSB first)
Null	0	0xFF 0xFF
0x0C 0x01 0x02 0x01 0x00	5	0xC2 0xB1
0x8C 0x01 0x05 0x00 0x01 0x00 0x01 0x05	8	0x48 0x33
0x0E 0x02 0x02 0x01 0x00	5	0x9D 0x6E
0x8E 0x02 0x08 0x00 0x01 0x00 0x04 0xFF 0xFF 0xFF 0x00	11	0xF2 0x4F
0x0D 0x03 0x07 0x01 0x00 0x04 0x01 0x00 0x00 0x00	10	0x8D 0xC4
0x8D 0x03 0x01 0x00	4	0x0A1F

Table 16: CRC Test Vectors



Contact

Würth Elektronik eiSos GmbH & Co. KG
Division Wireless Connectivity & Sensors

Max-Eyth-Straße 1
74638 Waldenburg
Germany

Tel.: +49 651 99355-0
Fax.: +49 651 99355-69
www.we-online.com/wireless-connectivity

WÜRTH ELEKTRONIK MORE THAN YOU EXPECT